

AGENDA



ARCHITECTURAL REVIEW BOARD MEETING

CITY HALL, 385 SOUTH GOLIAD STREET, ROCKWALL, TEXAS

OCTOBER 15, 2024 IN THE CITY COUNCIL CONFERENCE ROOM AT 5:00 PM

NOTES ABOUT PUBLIC PARTICIPATION = *RED*

(I) CALL TO ORDER

(II) OPEN FORUM

This is a time for anyone to address the Architectural Review Board (ARB) on any topic. Per the policies of the City of Rockwall, public comments are limited to three (3) minutes out of respect for the time of other citizens. On topics raised during the OPEN FORUM, please know that the Architectural Review Board (ARB) is not permitted to respond to your comments during the meeting per the Texas Open Meetings Act.

(III) ACTION AGENDA

(1) **SP2024-040 (HENRY LEE)**

Discuss and consider a request by Mckenzie Joseck of BGE, Inc. on behalf of Shawn Valk of Saro Partners, LLC for the approval of a Site Plan for two (2) Office Buildings on a 2.72-acre tract of land identified as Tract 26-4 of the W. W. Ford Survey, Abstract No. 80, City of Rockwall, Rockwall County, Texas, zoned Commercial (C) District, addressed as 5543 Horizon Road [FM-3097], and take any action necessary.

(IV) ADJOURNMENT

The City of Rockwall Planning and Zoning Commission reserves the right to adjourn into executive session at any time to discuss any matters listed on the agenda above, as authorized by Texas Government Code §551.071 (Consultation with City Attorney).

This facility is wheelchair accessible and accessible parking spaces are available. Request for accommodations or interpretive services must be made 48 hours prior to this meeting. Please contact the City Secretary's Office at (972) 772-6406 for further information.

I, Melanie Zavala, Planning and Zoning Coordinator for the City of Rockwall, Texas, do hereby certify that this Agenda was posted at City Hall, in a place readily accessible to the general public at all times, on October 11, 2024 prior to 5:00 PM, and remained so posted for at least 72 continuous hours preceding the scheduled time of said meeting.



CITY OF ROCKWALL

PLANNING AND ZONING COMMISSION CASE MEMO

PLANNING AND ZONING DEPARTMENT

385 S. GOLIAD STREET • ROCKWALL, TX 75087

PHONE: (972) 771-7745 • EMAIL: PLANNING@ROCKWALL.COM

TO: Planning and Zoning Commission
DATE: October 15, 2024
APPLICANT: McKenzie Joseck, BGE, Inc.
CASE NUMBER: SP2024-040; *Site Plan for 5543 Horizon Road*

SUMMARY

Discuss and consider a request by Mckenzie Joseck of BGE, Inc. on behalf of Shawn Valk of Saro Partners, LLC for the approval of a Site Plan for two (2) *Office Buildings* on a 2.72-acre tract of land identified as Tract 26-4 of the W. W. Ford Survey, Abstract No. 80, City of Rockwall, Rockwall County, Texas, zoned Commercial (C) District, addressed as 5543 Horizon Road [FM-3097], and take any action necessary.

BACKGROUND

The subject property was annexed into the City of Rockwall on May 17, 2004 by *Ordinance No. 04-34* [Case No. A2004-001]. On September 7, 2004, the City Council approved a zoning case [Case No. Z2004-027; *Ordinance No. 04-50*] to rezone the subject property from Agricultural (AG) District to Commercial (C) District. According to the Rockwall Central Appraisal District (RCAD) there is an 84 SF storage building, and a 250 SF shed located on the subject property, both constructed in 2009.

PURPOSE

On September 13, 2024, the applicant -- *McKenzie Joseck of BGE, Inc.* -- submitted an application requesting the approval of a Site Plan for the purpose of constructing an *Office Building* and a *Gym* on the subject property.

ADJACENT LAND USES AND ACCESS

The subject property is addressed as 5543 Horizon Road. The land uses adjacent to the subject property are as follows:

North: Directly north of the subject property are two (2) tracts of land (*i.e. Tracts 20-01 & 20-02 of the W. W. Ford Survey, Abstract No. 80*), one (1) developed with a single-family home (*i.e. 289 County Line Road*), and one (1) developed with several Commercial (C) District land uses. Beyond this is County Line Road, which is identified as a *Minor Collector* on the Master Thoroughfare Plan contained in the OURHometown Vision 2040 Comprehensive Plan

South: Directly south of the subject property is Horizon Road [FM-3097], which is identified as a A4D (*i.e. major arterial, four [4] lane, divided roadway*) on the Master Thoroughfare Plan contained in the OURHometown Vision 2040 Comprehensive Plan. Beyond this is the City of Rockwall Corporate City Limit.

East: Directly east of the subject property is a 4.97-acre tract of land (*i.e. Tract 26 of the W. W. Ford Survey, Abstract No. 80*), developed with a *Mini-Warehouse Facility*. Beyond this are two (2) parcels of land (*i.e. Lots 1-2 of the Rainbow Acres Addition*) developed with single-family homes. Following this is a 3.466-acre parcel of land (*i.e. Lot 1, Block A, Patriot Paws Addition*) developed with Commercial (C) District land use (*i.e. Patriot Paws*). All of these properties are zoned Commercial (C) District.

West: Directly west of the subject property is Horizon Road [FM-3097], which is identified as a A4D (*i.e. major arterial, four [4] lane, divided roadway*) on the Master Thoroughfare Plan contained in the OURHometown Vision 2040 Comprehensive Plan. Beyond this is a vacant 39.347-acre tract of land (*i.e. Tract 93-01 of the E. Teal Survey*,

Abstract No. 207) zoned Agricultural (AG) District. Following this is a 5.68-acre tract of land (i.e. Tract 3-1 of the E. Teal Survey, Abstract No. 207) established as a North Texas Municipal Water District property.

DENSITY AND DIMENSIONAL REQUIREMENTS

According to Section 01, *Land Use Schedule*, of Article 04, *Permissible Uses*, of the Unified Development Code (UDC), an *Office Building* and a *Gym* are permitted *by-right* land uses in a Commercial (C) District. The submitted site plan, landscape plan, treescape plan, photometric plan, and building elevations generally conform to the technical requirements contained within the Unified Development Code (UDC) for a property located within a Commercial (C) District with the exception of the items noted in the *Variances and Exceptions Requested by the Applicant* section of this case memo. A summary of the density and dimensional requirements for the subject property are as follows:

<i>Ordinance Provisions</i>	<i>Zoning District Standards</i>	<i>Conformance to the Standards</i>
<i>Minimum Lot Area</i>	10,000 SF	X=2.7391 acres; In Conformance
<i>Minimum Lot Frontage</i>	60-Feet	X= 234.38-feet; In Conformance
<i>Minimum Lot Depth</i>	100-Feet	X=501.75-feet; In Conformance
<i>Minimum Front Yard Setback</i>	15-Feet	X> 15-feet; In Conformance
<i>Minimum Rear Yard Setback</i>	10-Feet	X> 10-feet; In Conformance
<i>Minimum Side Yard Setback</i>	20-Feet	X> 20-feet; In Conformance
<i>Maximum Building Height</i>	60-Feet	X=30-feet; In Conformance
<i>Max Building/Lot Coverage</i>	60%	X=41.74%; In Conformance
<i>Minimum Number of Parking Spaces</i>	1 Parking Space/300 SF (Office) 1 Parking Space/200 SF (Gym) Total: 112 Parking Spaces	X=115; In Conformance
<i>Minimum Landscaping Percentage</i>	20%	X=29%; In Conformance
<i>Maximum Impervious Coverage</i>	85-90%	X=71%; In Conformance

TREESCAPE PLAN

The treescape plan provided by the applicant indicates a total of 15 caliper inches will be removed from the site during construction. Based on the landscape requirements, the applicant is providing 132 caliper inches of canopy trees on site, which will satisfy the required tree mitigation.

CONFORMANCE WITH THE CITY’S CODES

The applicant is requesting to construct an *Office Building* on the subject property. According to Subsection 02.02(D)(2), *Office and Professional Uses*, of Article 13, *Definitions*, of the Unified Development Code (UDC), an *Office Building* is defined as a “...(a) facility that provides executive, management, administrative, or professional services ... but not involving the sale of merchandise except as incidental to a permitted use...” In addition, Subsection 02.02(E)(9), *Recreation, Entertainment and Amusement Land Uses*, of Article 13, *Definitions*, of the Unified Development Code (UDC), a *Gym* is defined as a “... public or private facility operated to promote physical health and fitness. Activities may include exercise, physical therapy, training, and education pertaining to health and fitness. Uses or combinations of uses or facilities would typically include -- but are not limited to -- game courts, weight lifting and exercise equipment, aerobics, swimming pools and spas, and running or jogging tracks.” In this case, the applicant’s request for an *Office Building* and *Gym* is permitted by right according to Section 01, *Land Use Schedule*, of Article 04, *Permissible Uses*, of the Unified Development Code (UDC).

According to Subsection 01.06, *Residential Adjacency Standards*, of Article 05, *District Development Standards*, of the Unified Development Code (UDC), “(a)ny non-residential or multi-family land use or parking area that has a side or rear contiguous to any residentially zoned or used property shall be screened with a masonry fence a minimum of six (6) feet in height with canopy trees planted on 20-foot centers...” In addition, “(a)s an alternative, the Planning and Zoning Commission may approve an alternative screening method that incorporates a wrought iron fence and three (3) tiered screening (i.e. [1] *small to mid-sized shrubs, large shrubs or accent trees, and canopy trees* or [2] *evergreen trees and canopy trees*) along the entire length of the adjacency...” In this case, the applicant is proposing an alternative screening method that incorporates the three (3) tiered landscaping as mid-sized shrubs, large shrubs, and canopy trees; however, the applicant is not providing the wrought iron fence. The proposed screening represents an exception to the Unified Development Code (UDC), and the Planning and

Zoning Commission must include this item with their motion. The proposed site plan also generally conforms to the requirements of the *General Commercial District Standards* as stipulated by Article 05, *District Development Standards*, of the Unified Development Code (UDC), with the exception of the exception being requested as outlined in the *Variations and Exceptions Requested by the Applicant* section of this case memo.

VARIANCES AND EXCEPTIONS BY THE APPLICANT

As stated above, the applicant's request conforms to the majority of the City's codes; however, staff has identified the following exceptions:

- (1) *Building Standards*. According to Subsection 04.01(C), *General Commercial District Standards*, of Article 05, *District Development Standards*, of the UDC, all buildings are required to meet the primary and secondary articulation standards as described and depicted in *Figure 7: Commercial Building Articulation Standards*, contained in Article 05, of the UDC. In this case, both of the applicant's buildings do not comply with the primary and secondary articulation standards. This will require an exception from the Planning and Zoning Commission.
- (2) *Residential Adjacency*. According to Subsection 01.06, *Residential Adjacency Standards*, of Article 05, *District Development Standards*, of the Unified Development Code (UDC), "(a)ny non-residential or multi-family land use or parking area that has a side or rear contiguous to any residentially zoned or used property shall be screened with a masonry fence a minimum of six (6) feet in height with canopy trees planted on 20-foot centers..." In addition, "(a)s an alternative, the Planning and Zoning Commission may approve an alternative screening method that incorporates a wrought iron fence and three (3) tiered screening (*i.e.* [1] *small to mid-sized shrubs, large shrubs or accent trees, and canopy trees* or [2] *evergreen trees and canopy trees*) along the entire length of the adjacency..." In this case, the applicant is proposing an alternative screening method that incorporates the three (3) tiered landscaping, without the wrought iron fence. This will require an exception from the Planning and Zoning Commission.

According to Subsection 09, *Exceptions and Variances*, of Article 11, *Development Applications and Review Procedures*, of the Unified Development Code (UDC), an applicant may request the Planning and Zoning Commission grant variances and exceptions to the provisions contained in the Unified Development Code (UDC), where unique or extraordinary conditions exist or where strict adherence to the technical requirements of the Unified Development Code would create an undue hardship. In addition, the code requires that the applicant provide compensatory measures that directly offset the requested variances and exceptions. At this time, the applicant is not proposing any compensatory measures. That being said, the applicant's letter details that there is an existing row of trees between the subject property and the residentially used property, and in order to install the required wrought iron fence this row of trees would need to be removed. The applicant believes that "...it is in the best interest of both the current residents and our Client to preserve the existing trees instead of installing an open metal fence in this instance." Staff should note that based on the provided treescape plan only one (1) tree greater than four (4) caliper inches is located on the subject property along this shared property line, which can be seen in the *Figure 1*. Given this, the request to keep the existing trees in lieu of the required wrought iron fence does not appear to offset requested exception to the *Residential Adjacency Standards*. Requests for exceptions and variances to the Unified Development Code (UDC) are discretionary decisions for the Planning and Zoning Commission. Staff should note that a supermajority vote (*e.g. six [6] out of the seven [7] commissioners*) -- with a minimum of four (4) votes in the affirmative -- is required for the approval of a variance or exception.

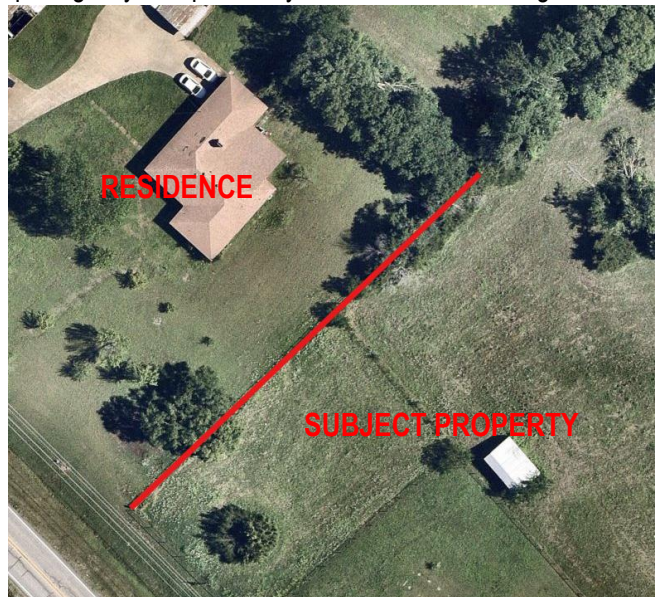

FIGURE 1. AERIAL OF SHARED PROPERTY LINE BETWEEN THE SUBJECT PROPERTY AND THE RESIDENTIALLY USED PROPERTY.

CONFORMANCE WITH OURHOMETOWN VISION 2040 COMPREHENSIVE PLAN

According to the *Land Use Plan* contained in the OURHometown Vision 2040 Comprehensive Plan, the subject property is located within the *Southwest Residential District* and is designated for *Commercial/Retail* land uses. The *District Strategies* for the *Southwest Residential District* designate the subject property as a *Transitional Area* or an area "...currently transitioning from interim land uses and building types to more permanent structures with conforming land uses. These areas should be given special consideration with regard to requests that further the establishment of uses and structures that will improve the property values of the adjacent properties ...". In this case, the proposed site plan would establish a development with conforming land uses (*i.e. Office Building and Gym*) and remove two (2) non-conforming accessory buildings. According to Goal 03, *Visual Impacts*, Policy 4, of Chapter 09, *Non-Residential*, of the OURHometown Vision 2040 Comprehensive Plan, "(l)ong, blank wall facades on all nonresidential buildings should be subdivided with vertical breaks -- or "articulated" in architectural terms..." In this case, the applicant is requesting an exception to the articulation requirements; however, as a compensatory measure the applicant is providing stone on the building in amounts of 6.75%-32.17% depending on the façade. The addition of stone brings the proposed building closer in line with Goal 04, *Commercial Building Design*, of Chapter 09, *Non-Residential*, of the OURHometown Vision 2040 Comprehensive Plan, which states that "(a)ll non-residential buildings should ... incorporate high quality materials..." With all that being said, the applicant's request appears to generally conform with the OURHometown Vision 2040 Comprehensive Plan.

ARCHITECTURAL REVIEW BOARD (ARB) RECOMMENDATION

On September 24, 2024, the Architecture Review Board (ARB) reviewed the proposed building elevations and recommended that the applicant provide stone in lieu of the dark grey stucco, finish the backsides of the parapets, provide a new material sample board, provide an exhibit of the awning projections and articulation, and remove the signage from the building elevations. The Architecture Review Board (ARB) will review the updated elevations at the October 15, 2024 meeting.

CONDITIONS OF APPROVAL

If the Planning and Zoning Commission chooses to approve the applicant's *Site Plan* for the construction of an *Office Building* and *Gym* on the *subject property*, then staff would propose the following conditions of approval:

- (1) All staff comments provided by the Planning, Engineering and Fire Department must be addressed prior to the submittal of engineering plans; and,
- (2) The accessory buildings on the subject property must be removed during construction; and,
- (3) The dumpster enclosure must be faced in the same stone material as the primary structure; and,
- (4) Any construction resulting from the approval of this *Site Plan* shall conform to the requirements set forth by the Unified Development Code (UDC), the International Building Code (IBC), the Rockwall Municipal Code of Ordinances, city adopted engineering and fire codes and with all other applicable regulatory requirements administered and/or enforced by the state and federal government.



DEVELOPMENT APPLICATION

City of Rockwall
Planning and Zoning Department
385 S. Goliad Street
Rockwall, Texas 75087

STAFF USE ONLY

PLANNING & ZONING CASE NO. _____

NOTE: THE APPLICATION IS NOT CONSIDERED ACCEPTED BY THE CITY UNTIL THE PLANNING DIRECTOR AND CITY ENGINEER HAVE SIGNED BELOW.

DIRECTOR OF PLANNING: _____

CITY ENGINEER: _____

PLEASE CHECK THE APPROPRIATE BOX BELOW TO INDICATE THE TYPE OF DEVELOPMENT REQUEST [SELECT ONLY ONE BOX]:

PLATTING APPLICATION FEES:

- MASTER PLAT (\$100.00 + \$15.00 ACRE) ¹
- PRELIMINARY PLAT (\$200.00 + \$15.00 ACRE) ¹
- FINAL PLAT (\$300.00 + \$20.00 ACRE) ¹
- REPLAT (\$300.00 + \$20.00 ACRE) ¹
- AMENDING OR MINOR PLAT (\$150.00)
- PLAT REINSTATEMENT REQUEST (\$100.00)

SITE PLAN APPLICATION FEES:

- SITE PLAN (\$250.00 + \$20.00 ACRE) ¹
- AMENDED SITE PLAN/ELEVATIONS/LANDSCAPING PLAN (\$100.00)

ZONING APPLICATION FEES:

- ZONING CHANGE (\$200.00 + \$15.00 ACRE) ¹
- SPECIFIC USE PERMIT (\$200.00 + \$15.00 ACRE) ^{1 & 2}
- PD DEVELOPMENT PLANS (\$200.00 + \$15.00 ACRE) ¹

OTHER APPLICATION FEES:

- TREE REMOVAL (\$75.00)
- VARIANCE REQUEST/SPECIAL EXCEPTIONS (\$100.00) ²

NOTES:

¹: IN DETERMINING THE FEE, PLEASE USE THE EXACT ACREAGE WHEN MULTIPLYING BY THE PER ACRE AMOUNT. FOR REQUESTS ON LESS THAN ONE ACRE, ROUND UP TO ONE (1) ACRE.

²: A **\$1,000.00** FEE WILL BE ADDED TO THE APPLICATION FEE FOR ANY REQUEST THAT INVOLVES CONSTRUCTION WITHOUT OR NOT IN COMPLIANCE TO AN APPROVED BUILDING PERMIT.

PROPERTY INFORMATION [PLEASE PRINT]

ADDRESS 5573 FM 3097, Rockwall, TX 75032

SUBDIVISION N/A

LOT

BLOCK

GENERAL LOCATION NE side of Horizon Rd approximately 1000ft south of County Line Rd.

ZONING, SITE PLAN AND PLATTING INFORMATION [PLEASE PRINT]

CURRENT ZONING C CURRENT USE Undeveloped/Agricultural

PROPOSED ZONING No Change PROPOSED USE Commercial Office/Retail

ACREAGE 2.72 AC LOTS [CURRENT] 1 LOTS [PROPOSED] 2

SITE PLANS AND PLATS: BY CHECKING THIS BOX YOU ACKNOWLEDGE THAT DUE TO THE PASSAGE OF HB3167 THE CITY NO LONGER HAS FLEXIBILITY WITH REGARD TO ITS APPROVAL PROCESS, AND FAILURE TO ADDRESS ANY OF STAFF'S COMMENTS BY THE DATE PROVIDED ON THE DEVELOPMENT CALENDAR WILL RESULT IN THE DENIAL OF YOUR CASE.

OWNER/APPLICANT/AGENT INFORMATION [PLEASE PRINT/CHECK THE PRIMARY CONTACT/ORIGINAL SIGNATURES ARE REQUIRED]

OWNER Saro Partners, LLC

APPLICANT BGE Inc.

CONTACT PERSON Shawn Valk

CONTACT PERSON Mckenzie Joseck

ADDRESS 1450 S. T L Townsend, Suite 100

ADDRESS 700 N Pearl St.

Suite 2100

CITY, STATE & ZIP Rockwall, TX 75032

CITY, STATE & ZIP Dallas, TX 75201

PHONE 469-222-1597

PHONE 972-372-9423

E-MAIL Shawnavalk@gmail.com

E-MAIL mjoseck@bgeinc.com

NOTARY VERIFICATION [REQUIRED]

BEFORE ME, THE UNDERSIGNED AUTHORITY, ON THIS DAY PERSONALLY APPEARED Shawn Valk [OWNER] THE UNDERSIGNED, WHO STATED THE INFORMATION ON THIS APPLICATION TO BE TRUE AND CERTIFIED THE FOLLOWING:

"I HEREBY CERTIFY THAT I AM THE OWNER FOR THE PURPOSE OF THIS APPLICATION; ALL INFORMATION SUBMITTED HEREIN IS TRUE AND CORRECT; AND THE APPLICATION FEE OF \$ 250.00 TO COVER THE COST OF THIS APPLICATION, HAS BEEN PAID TO THE CITY OF ROCKWALL ON THIS THE 10 DAY OF September, 20 24 BY SIGNING THIS APPLICATION, I AGREE THAT THE CITY OF ROCKWALL (I.E. "CITY") IS AUTHORIZED AND PERMITTED TO PROVIDE INFORMATION CONTAINED WITHIN THIS APPLICATION TO THE PUBLIC. THE CITY IS ALSO AUTHORIZED AND PERMITTED TO REPRODUCE AND DISSEMINATE INFORMATION SUBMITTED IN CONJUNCTION WITH THIS APPLICATION, IF SUCH REPRODUCTION IS ASSOCIATED OR IN RESPONSE TO A REQUEST FOR PUBLIC INFORMATION."

GIVEN UNDER MY HAND AND SEAL OF OFFICE ON THIS THE 10 DAY OF September, 20 24

OWNER'S SIGNATURE

NOTARY PUBLIC IN AND FOR THE STATE OF TEXAS

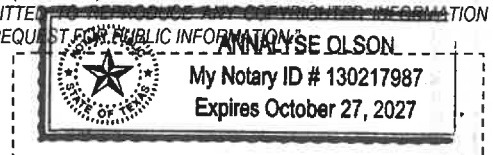

MY COMMISSION EXPIRES October 27, 2027

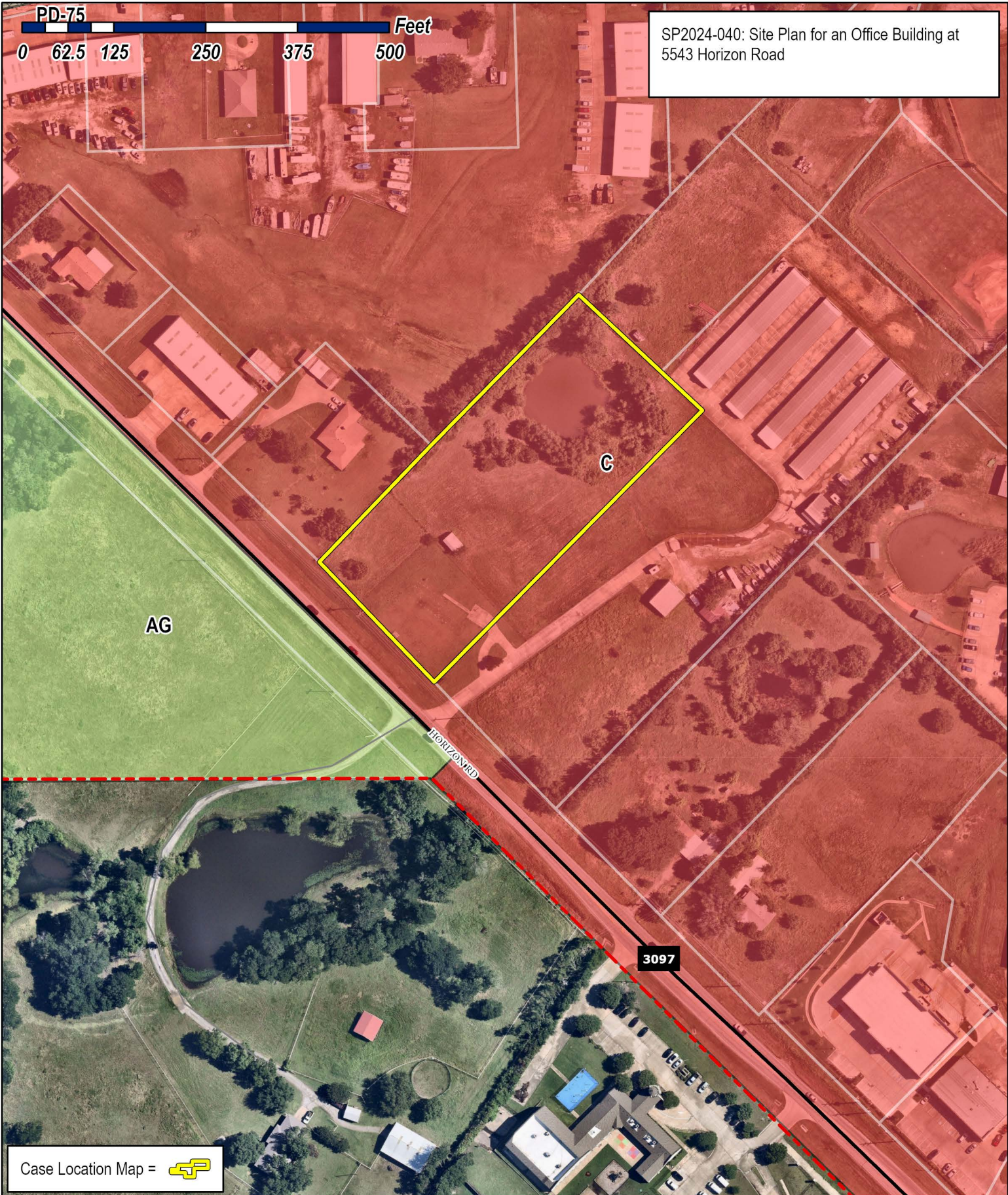

SP2024-040: Site Plan for an Office Building at 5543 Horizon Road

PD-75
0 62.5 125 250 375 500 Feet

AG

C

HORIZON RD

3097

Case Location Map = 



City of Rockwall

Planning & Zoning Department
385 S. Goliad Street
Rockwall, Texas 75087
(P): (972) 771-7745
(W): www.rockwall.com

The City of Rockwall GIS maps are continually under development and therefore subject to change without notice. While we endeavor to provide timely and accurate information, we make no guarantees. The City of Rockwall makes no warranty, express or implied, including warranties of merchantability and fitness for a particular purpose. Use of the information is the sole responsibility of the user.



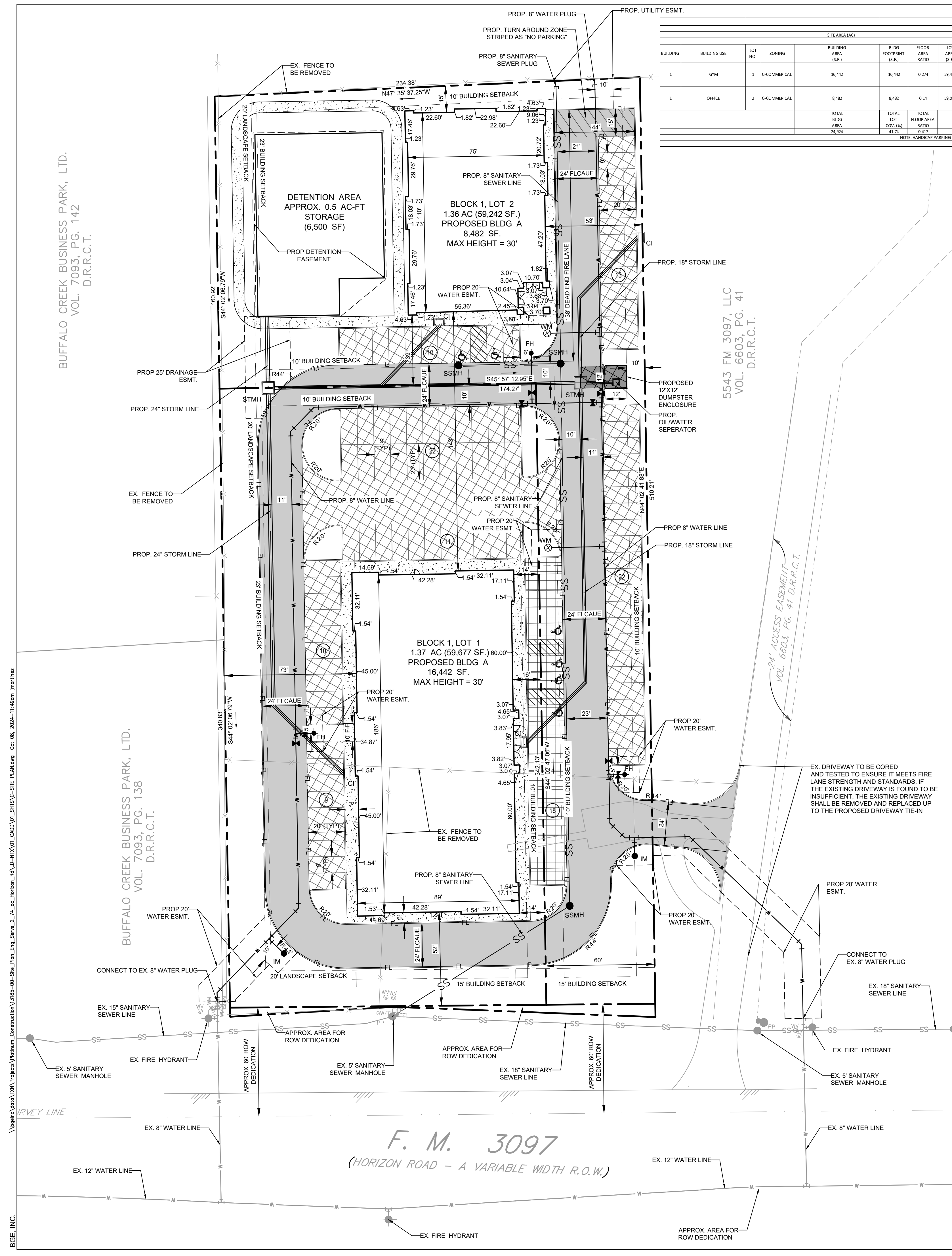

SITE INFORMATION											
SITE AREA (AC)		SITE DATA SUMMARY									
BLDG	BLDG USE	LOT NO.	ZONING	BLDG AREA (S.F.)	FLOOR FOOTPRINT (S.F.)	FLOOR AREA RATIO	LOT COV. (%)	IMP/PERVIOUS LOT COV. (%)	PROPOSED BLDG HEIGHT	PROP. BLDG STORES	PARKING RATIO
1	OFFICE	1	C-COMMERCIAL	16,442	16,442	0.274	99.497	27.37	46.430	42	1/100 (OFFICE)
1	OFFICE	2	C-COMMERCIAL	8,482	8,482	0.14	99.025	14.37	33.881	24	1/300 (OFFICE)
TOTAL				24,924	24,924	0.214	99.522	41.74	80.311	66	1/165 (OFFICE)

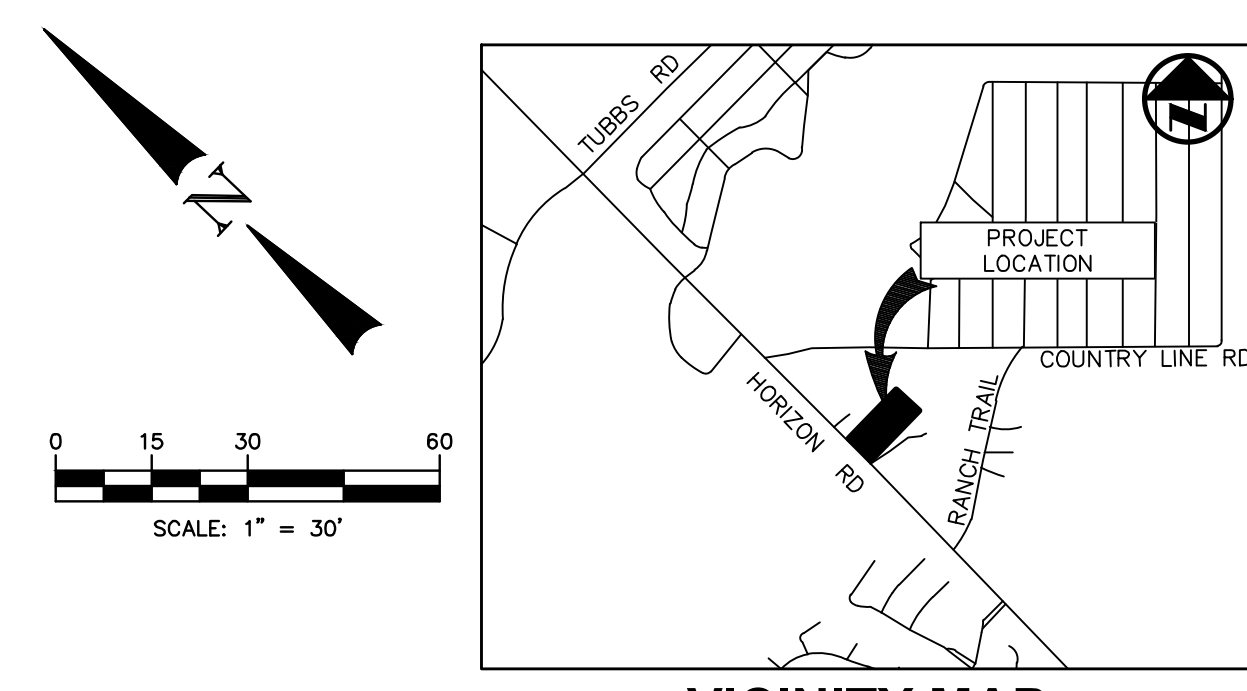

LEGEND

	PROPERTY LINE
	EASEMENT LINE
	PROP. CONCRETE SIDEWALK (TYP.)
	PROP. FIRE LANE, ACCESS & UTILITY ESMT.
	5' LIGHT DUTY CONCRETE PAVEMENT
	6' MEDIUM DUTY CONCRETE PAVEMENT
	7' DUMPSTER CONCRETE PAVEMENT
	EXISTING FENCE
	EXISTING MANHOLE
	EXISTING FIRE HYDRANT
	EXISTING SANITARY SEWER LINE
	EXISTING WATER LINE
	PROPOSED STORM SEWER LINE
	PROPOSED WATER LINE
	PROPOSED SANITARY SEWER LINE
	PROPOSED SANITARY SEWER MANHOLE
	PROPOSED IRRIGATION METER
	PROPOSED DOMESTIC METER
	PROPOSED GATE VALVE
	FIRE DEPARTMENT CONNECTION
	PROPOSED FIRE HYDRANT ASSEMBLY
	PROPOSED WYE INLET
	PROPOSED CURB INLET

KEY

TYP	TYPICAL	PP	POWER POLE
BFR	BARRIER FREE RAMP	ESMT	EASEMENT
FH	FIRE HYDRANT	(#)	NUMBER OF PARKING SPACES
SSMH	SEWER MANHOLE	STMH	STORM MANHOLE
LP	LIGHT POLE	WYE	WYE INLET
CI	CURB INLET	FDC	FIRE DEPARTMENT CONNECTION
WM	WATER METER	WV	WATER VALVE
EB	ELECTRICAL BOX	GW	GUY WIRE
IM	IRRIGATION METER	FLCAUE	FIRE LANE, CROSS ACCESS & UTILITY ESMT.

- NOTES:**
- CONTRACTOR TO NOTIFY ENGINEER IF EXISTING CONDITIONS VARY FROM THOSE SHOWN.
 - ALL WORK AND MATERIALS SHALL COMPLY WITH CITY AND COUNTY REGULATIONS AS WELL AS O.S.H.A STANDARDS.
 - ALL DIMENSIONS ARE TO THE FACE OR CURB UNLESS OTHERWISE NOTED.
 - ALL FIRE LANE RADI ARE 20-FOOT MINIMUM.
 - ALL FIRE LANES ARE 24-FEET WIDE MINIMUM.
 - HANDICAP PARKING AND MARKING SHALL BE IN ACCORDANCE WITH ADA STANDARDS.
 - REFER TO CITY OF ROCKWALL CONSTRUCTION DETAILS AND SPECIFICATIONS.
 - ALL SCREENING SHALL BE IN ACCORDANCE WITH CITY OF ROCKWALL REQUIREMENTS.
 - CONTRACTOR TO COORDINATE WITH CITY TRAFFIC ENGINEER PRIOR TO INSTALLING ROAD SIGNS OR PAVEMENT MARKINGS.
 - RETAINING WALLS 3' OR OVER WILL REQUIRE TO BE ENGINEERED.
 - ALL RETAINING WALLS (18' OR TALLER) MUST BE ROCK OR STONE FACE. NO SMOOTH CONCRETE WALLS.
 - SHARED PARKING BETWEEN LOTS WILL BE DONE THROUGH A SHARED PARKING AGREEMENT PRIOR TO THE ISSUANCE OF A CERTIFICATE OF OCCUPANCY.
 - NO OUTSIDE STORAGE OR ABOVE GROUND STORAGE TANKS SHALL BE PRESENT ON SITE.

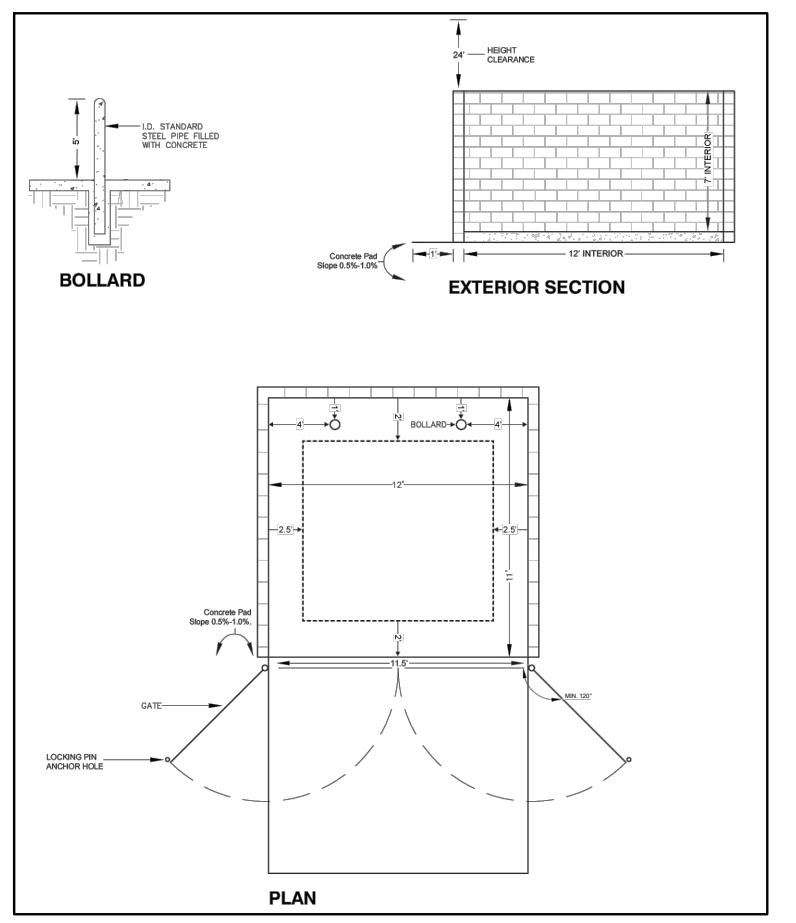

APPROVED: I hereby certify that the above and foregoing site plan for a development in the City of Rockwall, Texas, was approved by the Planning & Zoning Commission of the City of Rockwall on the _____ day of _____.

WITNESS OUR HANDS, this _____ day of _____.

Planning & Zoning Commission, Chairman Director of Planning and Zoning

SITE PLAN
CASE NUMBER: SP2024-040
HORIZON ROAD COMMERCIAL OFFICES
2.7391 ACRES (119316 SF.) BEING SITUATED IN
THE W.W FORD SURVEY, ABSTRACT NO. 80
CITY OF ROCKWALL, ROCKWALL COUNTY, TEXAS
 SUBMITTED: SEPTEMBER 13, 2024
 RESUBMITTED: OCTOBER 1, 2024

BGE, Inc.
 2595 Dallas Parkway, Suite 101
 Frisco, TX 75034
 Tel: 972-464-4800 • www.bgeinc.com
 TBPE Registration No. F-1046
 Copyright 2020

DEVELOPER
PLATINUM CONSTRUCTION
 1450 TL TOWNSEND DR. STE 100
 ROCKWALL, TX 75032
 TEL: (469) 222-1597
 CONTACT: SHAWN WALK

OWNER
SARO PARTNERS LLC
 1450 S. T L TOWNSEND
 ROCKWALL, TX 75032
 TEL: (469) 222-1597
 CONTACT: SHAWN WALK

PLATINUM CONSTRUCTION
SITE PLAN
HORIZON RD. COMMERCIAL OFFICES
W.W FORD SURVEY, ABSTRACT NO. 80, TRACT
26-4
CITY OF ROCKWALL, ROCKWALL COUNTY, TEXAS

THESE PLANS ARE ISSUED FOR THE PURPOSE OF PRELIMINARY REVIEW AND ARE NOT INTENDED FOR CONSTRUCTION. WHEN ISSUED IN FINAL FORM THEY WILL BE SEALED, SIGNED AND DATED.

RESPONSIBLE ENGINEER:
 BGE, INC.
 TEXAS REGISTERED ENGINEERING FIRM F-1046
 MCKENZIE L. JOSECK, P.E.
 TEXAS REGISTRATION NO. 149338
 OCTOBER 08, 2024

!CAUTION!
 Contractor to Verify exact location & Depth of Exist Facilities Prior to any Construction Activities

!CAUTION!
 CONTACT: 1-800-DIG-TESS
 48 HOURS PRIOR TO CONSTRUCTION

REVISIONS		
REV. NO.	DATE	DESCRIPTION

CHECKED BY: MLJ
 DESIGNED BY: JM
 DATE: OCTOBER 2024
 PROJECT NUMBER: SP2024-040

SHEET NO
SP-1

BUFFALO CREEK BUSINESS PARK, LTD.
 VOL. 7093, PG. 142
 D.R.R.C.T.

BUFFALO CREEK BUSINESS PARK, LTD.
 VOL. 7093, PG. 138
 D.R.R.C.T.

BGE, INC.

F. M. 3097
 (HORIZON ROAD - A VARIABLE WIDTH R.O.W.)

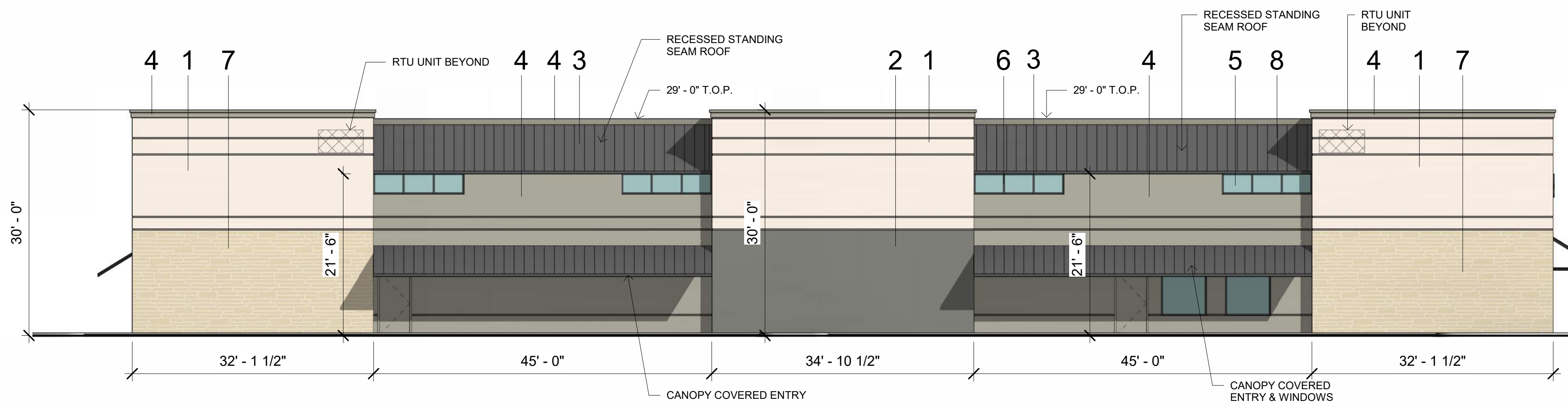

NORTH ELEVATION

3/32" = 1'-0"

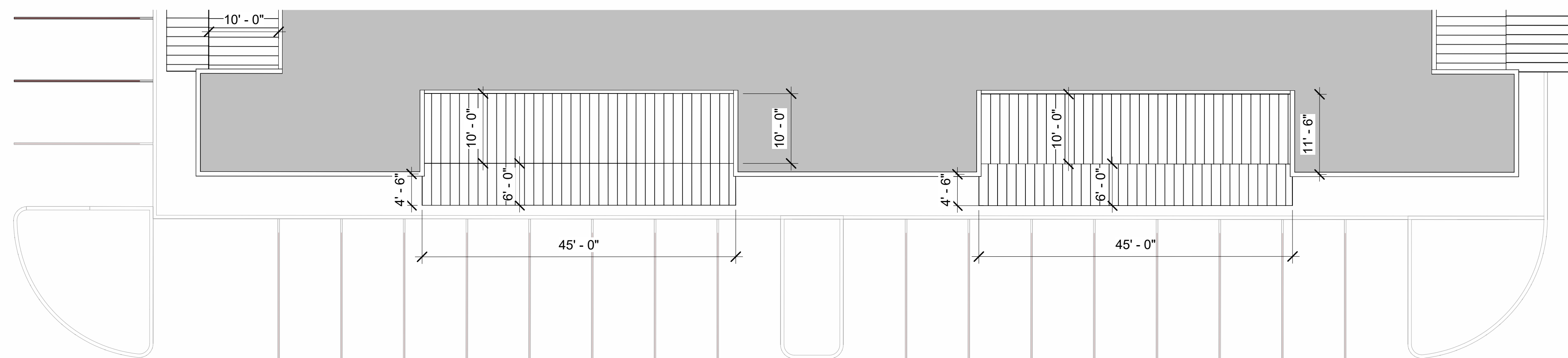

MATERIALS & COLORS:

- 1 - **STUCCO-PAINTED:**
MFG: DUNN-EDWARDS
COLOR: FRENCH WHITE
SPEC: DEW311
- 2 - **STUCCO-PAINTED:**
MFG: DUNN-EDWARDS
COLOR: STONE MASON
SPEC: DET615
- 3 - **PAINTED METAL:**
MFG: DUNN-EDWARDS
COLOR: CAVERNOUS
SPEC: DE6364
- 4 - **PAINTED STUCCO:**
MFG: DUNN-EDWARDS
COLOR: WHALE WATCHING
SPEC: DET512
- 5 - **GLAZING:**
MFG: SOLARBAN
COLOR: SOLARBAN 90(2) SOLARGRAY + CLEAR
VLT 26%
- 6 - **STOREFRONT MULLIONS:**
MFG: KAWNEER
COLOR: DARK BRONZE
- 7 - **STONE VENEER:**
MFG: CORONADO
COLOR: CAP COD GRAY
- 8 - **METAL ROOF:**
MFG: ATAS
COLOR: CLASSIC BRONZE(01)

MATERIAL CALCULATIONS -

1 - FRENCH WHITE - 30.75 %
2 - STONE MASON - 9.80%
4 - WHALE WATCHING - 41.38%
7 - STONE VENEER - 18%

NOTE:
BACKSIDE OF PARAPET TO BE FINISHED
THE SAME AS THE FRONT FACING FACADE

SECONDARY FACADE

ENTRY ELEMENT PROJECTION HEIGHT (H) = 30- FEET
(H)15% = 4.6- FEET

PROJECTIONS HEIGHT (H) = 21.6- FEET
(H)15% = 3.2- FEET

MATERIALS & COLORS:

- 1 - **STUCCO-PAINTED:**
MFG: DUNN-EDWARDS
COLOR: FRENCH WHITE
SPEC: DEW311
- 2 - **STUCCO-PAINTED:**
MFG: DUNN-EDWARDS
COLOR: STONE MASON
SPEC: DET615
- 3 - **PAINTED METAL:**
MFG: DUNN-EDWARDS
COLOR: CAVERNOUS
SPEC: DE6364
- 4 - **PAINTED STUCCO:**
MFG: DUNN-EDWARDS
COLOR: WHALE WATCHING
SPEC: DET512
- 5 - **GLAZING:**
MFG: SOLARBAN
COLOR: SOLARBAN 90(2) SOLARGRAY + CLEAR
VLT 26%
- 6 - **STOREFRONT MULLIONS:**
MFG: KAWNEER
COLOR: DARK BRONZE
- 7 - **STONE VENEER:**
MFG: CORONADO
COLOR: CAP COD GRAY
- 8 - **METAL ROOF:**
MFG: ATAS
COLOR: CLASSIC BRONZE(01)

MATERIAL CALCULATIONS -

1 - FRENCH WHITE - 32.62%
4 - WHALE WATCHING - 37.80%
7 - STONE VENEER - 29.56%

NOTE:
BACKSIDE OF PARAPET TO BE FINISHED
THE SAME AS THE FRONT FACING FACADE

SECONDARY FACADE

ENTRY ELEMENT PROJECTION HEIGHT (H) = 30- FEET
(H)15% = 4.6- FEET

PROJECTIONS HEIGHT (H) = 21.6- FEET
(H)15% = 3.2- FEET

EAST ELEVATION

3/32" = 1'-0"

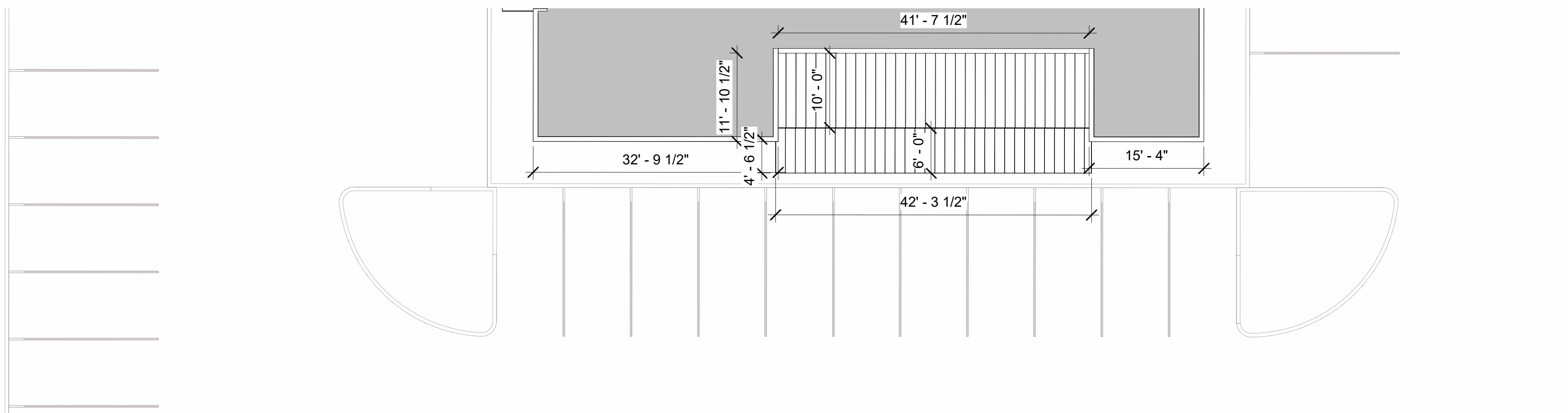
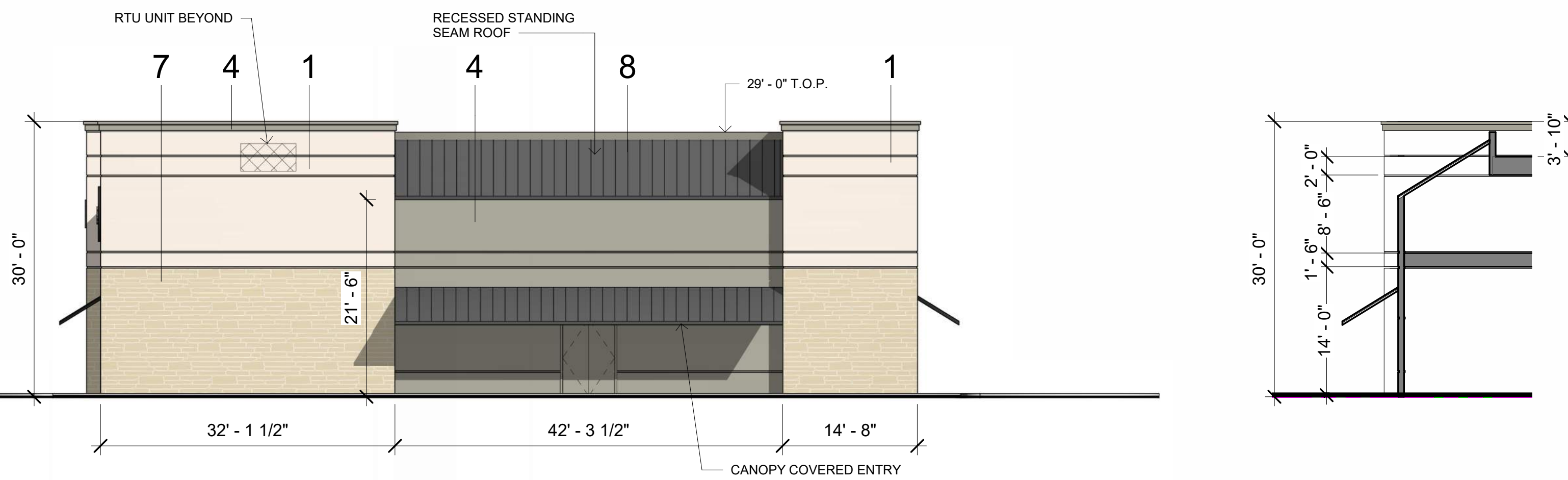

IRKAA
 2233 EAST THOMAS ROAD, PHOENIX, ARIZONA 85016
 602-955-3900
 RKA.A.COM
 DATE: 10-01-2024
 GYM - ELEVATIONS
 5543 HORIZON ROAD ROCKWALL, TEXAS
 (SCHEMATIC DESIGN)
 COPYRIGHT 2024. ALL RIGHTS RESERVED. THIS DRAWING IS A INSTRUMENT OF SERVICE. IT IS THE PROPERTY OF IRKAA ARCHITECTS AND ASSOCIATES, INC. AND MAY NOT BE REPRODUCED OR TRANSMITTED IN ANY FORM OR BY ANY MEANS, ELECTRONIC OR MECHANICAL, INCLUDING PHOTOCOPYING, RECORDING, OR BY ANY INFORMATION STORAGE AND RETRIEVAL SYSTEM, WITHOUT THE WRITTEN PERMISSION OF THE CORPORATION.
 DESIGN BY: KR
 DRAWN BY: KR
 CHECKED BY: NF
A1.1
 PROJECT #: 24216.50

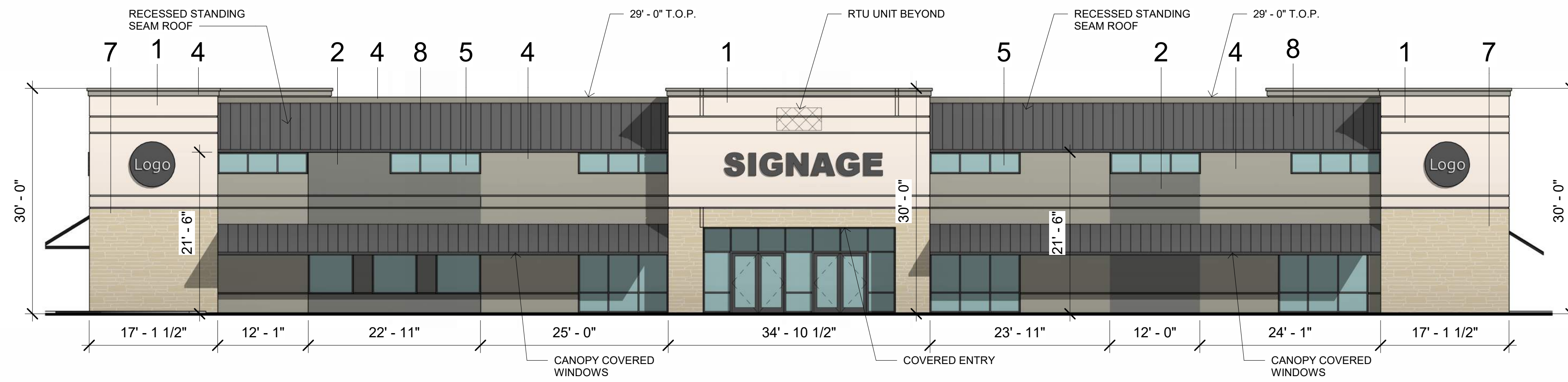

SOUTH ELEVATION

3/32" = 1'-0"

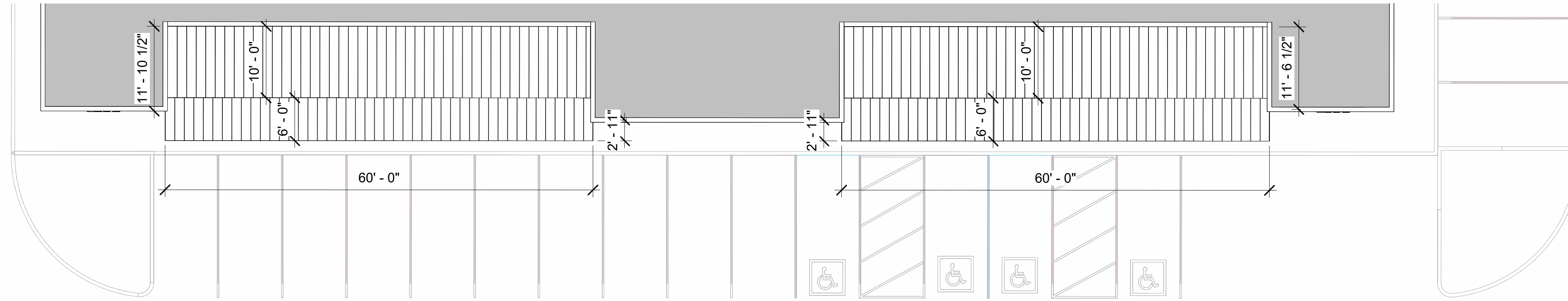

MATERIALS & COLORS:

- 1 - **STUCCO-PAINTED:**
MFG: DUNN-EDWARDS
COLOR: FRENCH WHITE
SPEC: DEW311
- 2 - **STUCCO-PAINTED:**
MFG: DUNN-EDWARDS
COLOR: STONE MASON
SPEC: DET615
- 3 - **PAINTED METAL:**
MFG: DUNN-EDWARDS
COLOR: CAVERNOUS
SPEC: DE6364
- 4 - **PAINTED STUCCO:**
MFG: DUNN-EDWARDS
COLOR: WHALE WATCHING
SPEC: DET512
- 5 - **GLAZING:**
MFG: SOLARBAN
COLOR: SOLARBAN 90(2) SOLARGRAY + CLEAR
VLT 26%
- 6 - **STOREFRONT MULLIONS:**
MFG: KAWNEER
COLOR: DARK BRONZE
- 7 - **STONE VENEER:**
MFG: CORONADO
COLOR: CAP COD GRAY
- 8 - **METAL ROOF:**
MFG: ATAS
COLOR: CLASSIC BRONZE(01)

MATERIAL CALCULATIONS -

1 - FRENCH WHITE - 28.85 %
2 - STONE MASON - 16.15%
4 - WHALE WATCHING - 36.20%
7 - STONE VENEER - 18.80%

NOTE:
BACKSIDE OF PARAPET TO BE FINISHED
THE SAME AS THE FRONT FACING FACADE

SECONDARY FACADE

ENTRY ELEMENT PROJECTION HEIGHT (H) = 30-FEET
(H)15% = 4.6-FEET

PROJECTIONS HEIGHT (H) = 21.6-FEET
(H)15% = 3.2-FEET

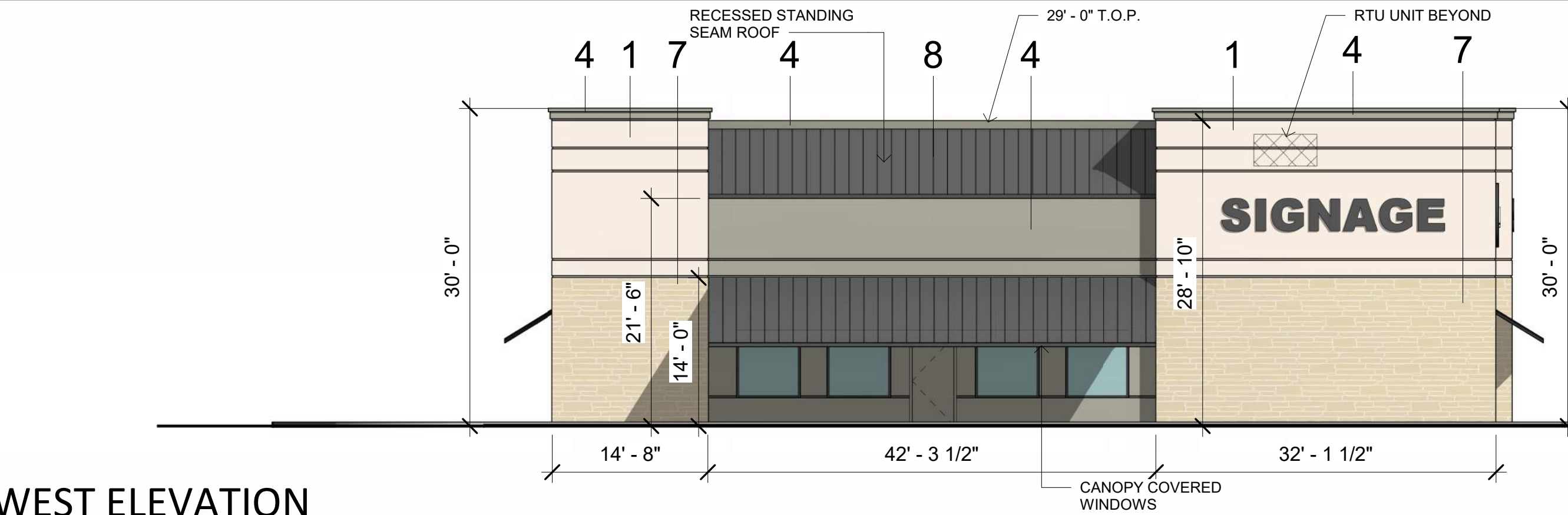

WEST ELEVATION

3/32" = 1'-0"

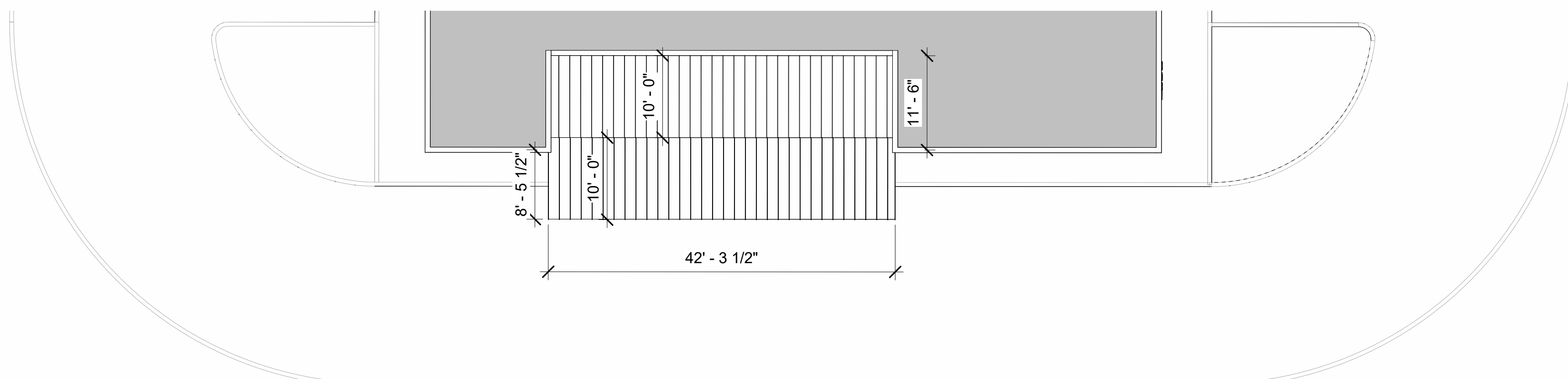

MATERIALS & COLORS:

- 1 - **STUCCO-PAINTED:**
MFG: DUNN-EDWARDS
COLOR: FRENCH WHITE
SPEC: DEW311
- 2 - **STUCCO-PAINTED:**
MFG: DUNN-EDWARDS
COLOR: STONE MASON
SPEC: DET615
- 3 - **PAINTED METAL:**
MFG: DUNN-EDWARDS
COLOR: CAVERNOUS
SPEC: DE6364
- 4 - **PAINTED STUCCO:**
MFG: DUNN-EDWARDS
COLOR: WHALE WATCHING
SPEC: DET512
- 5 - **GLAZING:**
MFG: SOLARBAN
COLOR: SOLARBAN 90(2) SOLARGRAY + CLEAR
VLT 26%
- 6 - **STOREFRONT MULLIONS:**
MFG: KAWNEER
COLOR: DARK BRONZE
- 7 - **STONE VENEER:**
MFG: CORONADO
COLOR: CAP COD GRAY
- 8 - **METAL ROOF:**
MFG: ATAS
COLOR: CLASSIC BRONZE(01)

MATERIAL CALCULATIONS -

1 - FRENCH WHITE - 35.50%
4 - WHALE WATCHING - 32.32%
7 - STONE VENEER - 32.17%

NOTE:
BACKSIDE OF PARAPET TO BE FINISHED
THE SAME AS THE FRONT FACING FACADE

PRIMARY FACADE

ENTRY ELEMENT PROJECTION HEIGHT (H) = 30-FEET
(H)25% = 7.6-FEET

LENGHT (L) = 42.375-FEET
(L)25% = 10.6-FEET



RKAA
2233 EAST THOMAS ROAD, PHOENIX, ARIZONA 85016
602-955-3900
RKAA.COM

DATE: 10-01-2024

GYM - ELEVATIONS

NOTICE OF ADEQUATE BILLING OR PAYMENT CYCLE:
THIS CONTRACTOR MAY ALLOW THE OWNER TO REQUIRE
THE SUBMITTER OF BILLING OR ESTIMATE TO
BILLING CYCLES OTHER THAN THIRTY DAYS. THIS
CONTRACTOR MAY ALLOW OWNER TO MAKE PAYMENT
ON SOME ALTERNATE SCHEDULES AFTER
CONFIRMATION AND APPROVAL OF BILLING AND
ESTIMATES. A WRITTEN DESCRIPTION OF SUCH OTHER
BILLING CYCLE APPLICABLE TO THE PROJECT IS
AVAILABLE FROM OWNER OR DESIGNATED AGENT.

NAME:
ADDRESS:
CONTACT:
PHONE:

5543 HORIZON ROAD ROCKWALL, TEXAS
(SCHEMATIC DESIGN)

COPYRIGHT 2024. ALL RIGHTS RESERVED. THIS
DRAWING IS A INSTRUMENT OF SERVICE. IT IS THE
PROPERTY OF ROBERT KUBACKI ARCHITECTS AND
ASSOCIATES, INC. AND MAY NOT BE REPRODUCED OR
REPRODUCTION WITHOUT WRITTEN
PERMISSION OF THE CORPORATION.

DESIGN BY: KR
DRAWN BY: KR
CHECKED BY: NF

A1.2
PROJECT #: 24216.50

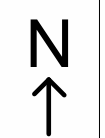



NOTICE OF ALTERNATE BILLING OR PAYMENT CYCLE:
 THIS CONTRACTOR MAY ALLOW THE OWNER TO REQUIRE
 THE SUBMISSION OF BILLING OR PAYMENTS IN
 BILLING CYCLES OTHER THAN THIRTY DAYS. THE
 CONTRACT MAY ALLOW OWNER TO MAKE PAYMENT
 ON SOME ALTERNATE SCHEDULE AFTER
 CONSULTATION AND APPROVAL OF BILLING AND
 ESTIMATES. A WRITTEN DESCRIPTION OF SUCH OTHER
 BILLING CYCLE APPLICABLE TO THE PROJECT IS
 AVAILABLE FROM OWNER OR DESIGNATED AGENT.
 NAME:
 ADDRESS:
 CONTACT:
 PHONE:

5543 HORIZON ROAD ROCKWALL, TEXAS
 (SCHEMATIC DESIGN)

COPYRIGHT 2024. ALL RIGHTS RESERVED. THIS
 DRAWING IS A INSTRUMENT OF SERVICE. IT IS THE
 PROPERTY OF ROBERT KUBACKI ARCHITECTS AND
 ASSOCIATES, INC. AND MAY NOT BE REPRODUCED OR
 REPRODUCTION WITHOUT WRITTEN
 PERMISSION OF THE CORPORATION.

DESIGN BY: KR
 DRAWN BY: KR
 CHECKED BY: NF

A1.3
 PROJECT #:24216.50

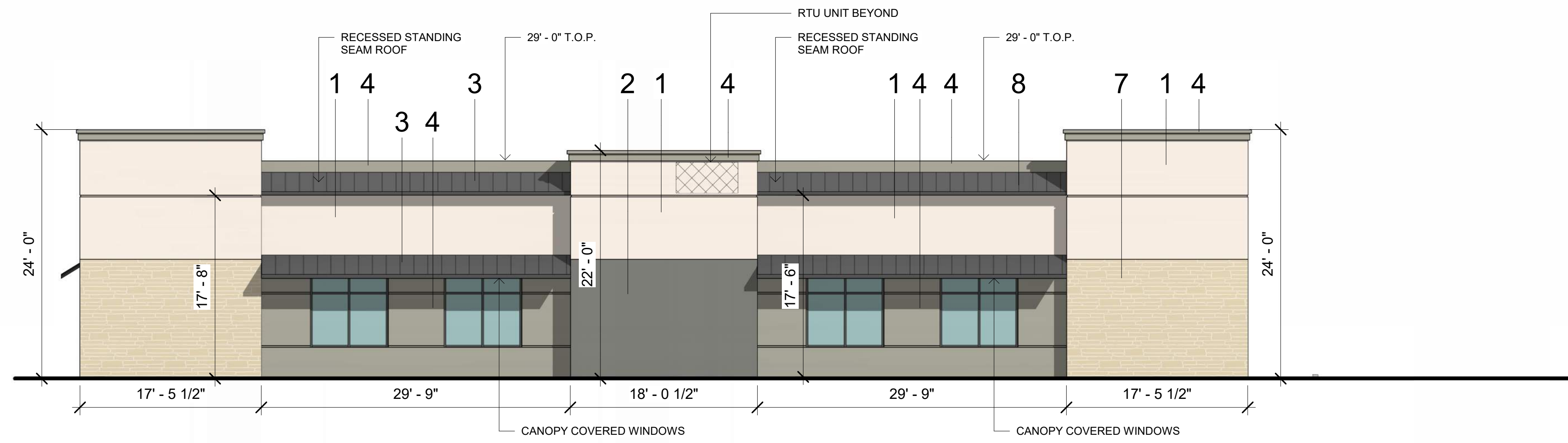

NORTH OFFICE BUILDING ELEVATION

1/8" = 1'-0"

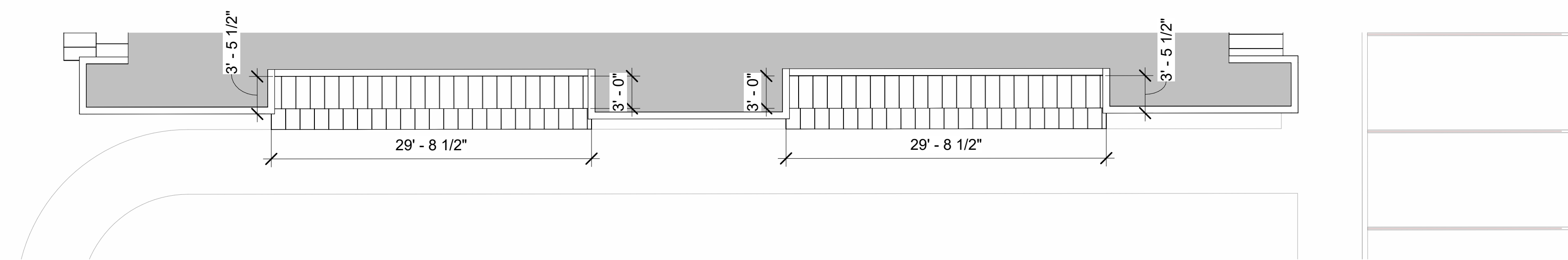

MATERIALS & COLORS:

- | | |
|--|--|
| <ul style="list-style-type: none"> 1 - STUCCO-PAINTED:
MFG: DUNN-EDWARDS
COLOR: FRENCH WHITE
SPEC: DEW311 2 - STUCCO-PAINTED:
MFG: DUNN-EDWARDS
COLOR: STONE MASON
SPEC: DET815 3 - PAINTED METAL:
MFG: DUNN-EDWARDS
COLOR: CAVERNOUS
SPEC: DE6364 4 - PAINTED STUCCO:
MFG: DUNN-EDWARDS
COLOR: WHALE WATCHING
SPEC: DET512 5 - GLAZING:
MFG: SOLARBAN
COLOR: SOLARBAN 90(2) SOLARGRAY + CLEAR
VLT: 26% 6 - STOREFRONT MULLIONS:
MFG: KAWNEER
COLOR: DARK BRONZE 7 - STONE VENEER:
MFG: CORONADO
COLOR: CAP COD GRAY 8 - METAL ROOF:
MFG: ATAS
COLOR: CLASSIC BRONZE(01) | <p>MATERIAL CALCULATIONS -</p> <ul style="list-style-type: none"> 1 - FRENCH WHITE - 40.30 % 2 - STONE MASON - 8.75% 4 - WHALE WATCHING - 34% 7 - STONE VENEER - 16.90% |
|--|--|

NOTE:
BACKSIDE OF PARAPET TO BE FINISHED THE SAME AS THE FRONT FACING FACADE

SECONDARY FACADE

ENTRY ELEMENT PROJECTION HEIGHT (H) = 24- FEET

(H)15% = 3.6- FEET

PROJECTIONS HEIGHT (H) = 17.8- FEET

(H)15% = 2.6- FEET

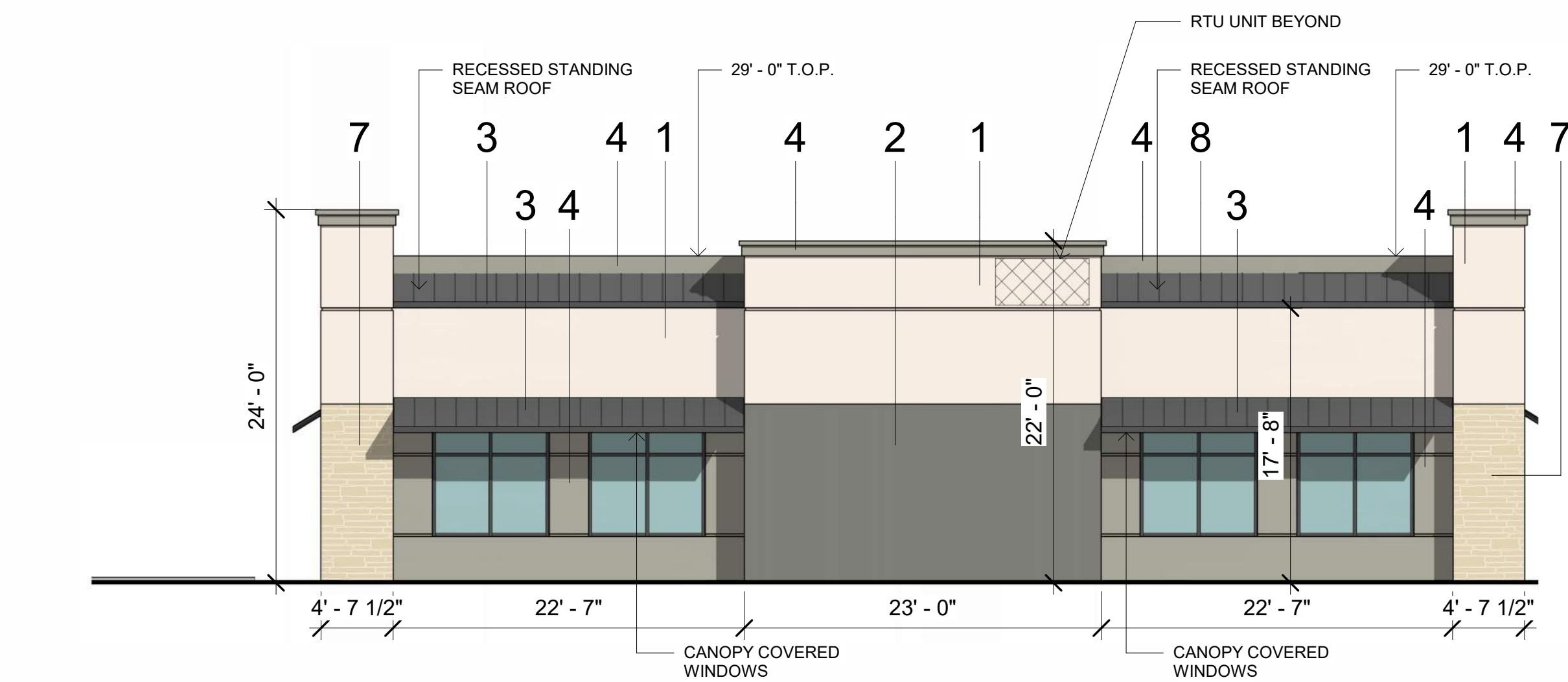

EAST OFFICE BUILDING ELEVATION

1/8" = 1'-0"

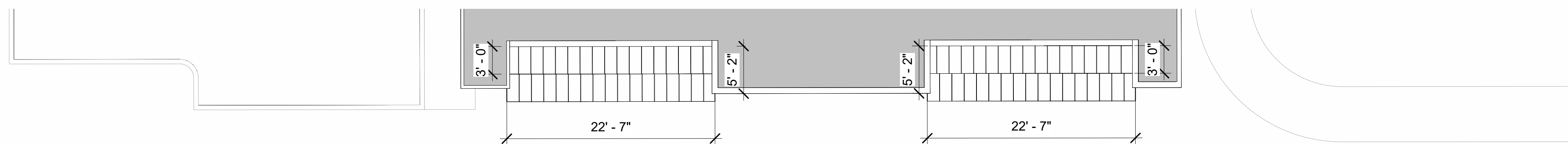

MATERIALS & COLORS:

- | | |
|--|---|
| <ul style="list-style-type: none"> 1 - STUCCO-PAINTED:
MFG: DUNN-EDWARDS
COLOR: FRENCH WHITE
SPEC: DEW311 2 - STUCCO-PAINTED:
MFG: DUNN-EDWARDS
COLOR: STONE MASON
SPEC: DET815 3 - PAINTED METAL:
MFG: DUNN-EDWARDS
COLOR: CAVERNOUS
SPEC: DE6364 4 - PAINTED STUCCO:
MFG: DUNN-EDWARDS
COLOR: WHALE WATCHING
SPEC: DET512 5 - GLAZING:
MFG: SOLARBAN
COLOR: SOLARBAN 90(2) SOLARGRAY + CLEAR
VLT: 26% 6 - STOREFRONT MULLIONS:
MFG: KAWNEER
COLOR: DARK BRONZE 7 - STONE VENEER:
MFG: CORONADO
COLOR: CAP COD GRAY 8 - METAL ROOF:
MFG: ATAS
COLOR: CLASSIC BRONZE(01) | <p>MATERIAL CALCULATIONS -</p> <ul style="list-style-type: none"> 1 - FRENCH WHITE - 38.23% 2 - STONE MASON - 16.75% 4 - WHALE WATCHING - 38.5% 7 - STONE VENEER - 6.75% |
|--|---|

NOTE:
BACKSIDE OF PARAPET TO BE FINISHED THE SAME AS THE FRONT FACING FACADE

SECONDARY FACADE

ENTRY ELEMENT PROJECTION HEIGHT (H) = 24- FEET

(H)15% = 3.6- FEET

PROJECTIONS HEIGHT (H) = 17.8- FEET

(H)15% = 2.6- FEET



RKAA
2233 EAST THOMAS ROAD, PHOENIX, ARIZONA 85016
602-955-3900
RKAA.com

DATE: 10-01-2024

OFFICE - ELEVATIONS

NOTICE OF ACCURATE BILLING OR NUMBER COUNT: THIS CONTRACTOR MAY ALLOW THE OWNER TO REQUIRE THE SUBMISSION OF BILLING OR ESTIMATES IN BILLING CYCLES OTHER THAN THIRTY DAYS. THIS CONTRACTOR MAY ALLOW OWNER TO MAKE PAYMENT ON SOME ALTERNATE SCHEDULE AFTER CONSULTATION AND APPROVAL OF BILLING AND ESTIMATES. A WRITTEN DESCRIPTION OF SUCH OTHER BILLING CYCLE APPLICABLE TO THE PROJECT IS AVAILABLE FROM OWNER OR DESIGNATED AGENT.

NAME: ADDRESS: CONTACT: PHONE:

MATERIALS & COLORS:

- | | |
|--|---|
| <ul style="list-style-type: none"> 1 - STUCCO-PAINTED:
MFG: DUNN-EDWARDS
COLOR: FRENCH WHITE
SPEC: DEW311 2 - STUCCO-PAINTED:
MFG: DUNN-EDWARDS
COLOR: STONE MASON
SPEC: DET815 3 - PAINTED METAL:
MFG: DUNN-EDWARDS
COLOR: CAVERNOUS
SPEC: DE6364 4 - PAINTED STUCCO:
MFG: DUNN-EDWARDS
COLOR: WHALE WATCHING
SPEC: DET512 5 - GLAZING:
MFG: SOLARBAN
COLOR: SOLARBAN 90(2) SOLARGRAY + CLEAR
VLT: 26% 6 - STOREFRONT MULLIONS:
MFG: KAWNEER
COLOR: DARK BRONZE 7 - STONE VENEER:
MFG: CORONADO
COLOR: CAP COD GRAY 8 - METAL ROOF:
MFG: ATAS
COLOR: CLASSIC BRONZE(01) | <p>MATERIAL CALCULATIONS -</p> <ul style="list-style-type: none"> 1 - FRENCH WHITE - 38.23% 2 - STONE MASON - 16.75% 4 - WHALE WATCHING - 38.5% 7 - STONE VENEER - 6.75% |
|--|---|

NOTE:
BACKSIDE OF PARAPET TO BE FINISHED THE SAME AS THE FRONT FACING FACADE

SECONDARY FACADE

ENTRY ELEMENT PROJECTION HEIGHT (H) = 24- FEET

(H)15% = 3.6- FEET

PROJECTIONS HEIGHT (H) = 17.8- FEET

(H)15% = 2.6- FEET

5543 HORIZON ROAD ROCKWALL, TEXAS
(SCHEMATIC DESIGN)

COPYRIGHT 2024. ALL RIGHTS RESERVED. THIS DRAWING IS A INSTRUMENT OF SERVICE. IT IS THE PROPERTY OF ROBERT KIRKLAND ARCHITECTS AND ASSOCIATES, INC. AND MAY NOT BE REPRODUCED OR REPRODUCTION WITHOUT WRITTEN PERMISSION OF THE CORPORATION.

DESIGN BY: KR
DRAWN BY: KR
CHECKED BY: NF

A2.1
PROJECT #: 24216.50



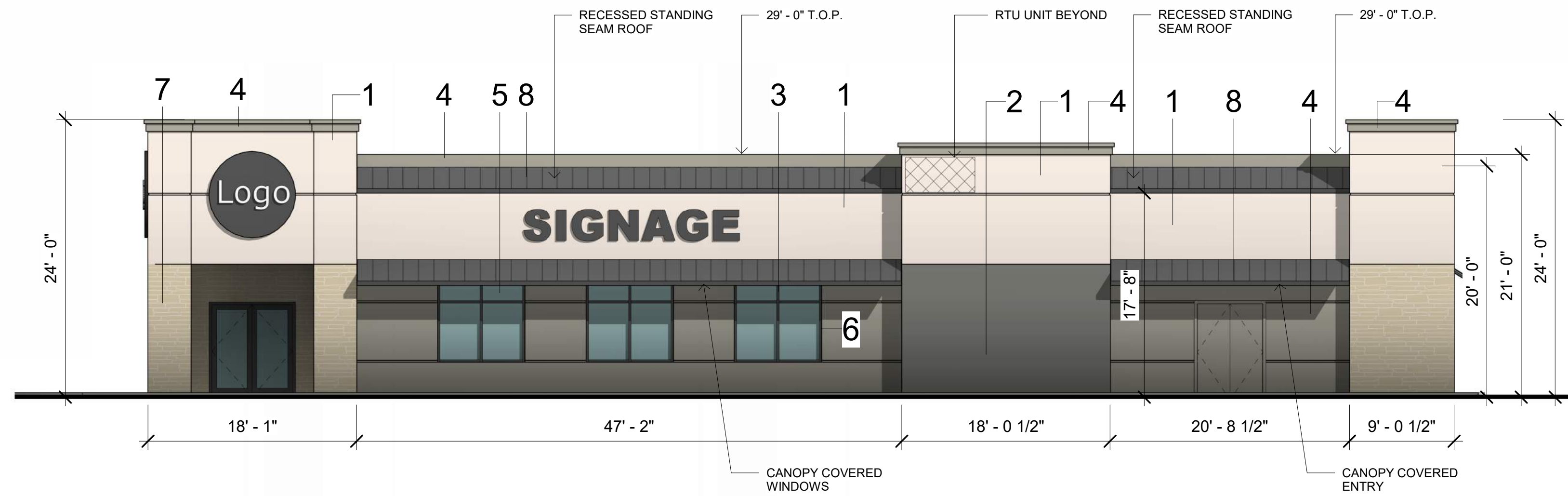

SOUTH OFFICE BUILDING ELEVATION

1/8" = 1'-0"

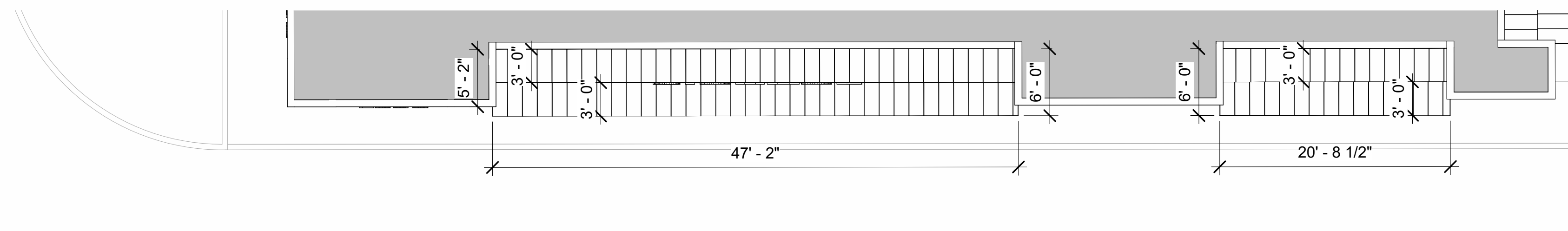

MATERIALS & COLORS:

- 1 - **STUCCO-PAINTED:**
MFG: DUNN-EDWARDS
COLOR: FRENCH WHITE
SPEC: DEW311
- 2 - **STUCCO-PAINTED:**
MFG: DUNN-EDWARDS
COLOR: STONE MASON
SPEC: DET615
- 3 - **PAINTED METAL:**
MFG: DUNN-EDWARDS
COLOR: CAVERNOUS
SPEC: DE6364
- 4 - **PAINTED STUCCO:**
MFG: DUNN-EDWARDS
COLOR: WHALE WATCHING
SPEC: DET512
- 5 - **GLAZING:**
MFG: SOLARBAN
COLOR: SOLARBAN 90(2) SOLARGRAY + CLEAR
VLT: 26%
- 6 - **STOREFRONT MULLIONS:**
MFG: KAWNEER
COLOR: DARK BRONZE
- 7 - **STONE VENEER:**
MFG: CORONADO
COLOR: CAP COD GRAY
- 8 - **METAL ROOF:**
MFG: ATAS
COLOR: CLASSIC BRONZE(01)

MATERIAL CALCULATIONS -

1 - FRENCH WHITE - 61.50 %
2 - STONE MASON - 11.82%
4 - WHALE WATCHING - 18.92%
7 - STONE VENEER - 17.74%

NOTE:
BACKSIDE OF PARAPET TO BE FINISHED
THE SAME AS THE FRONT FACING FACADE

SECONDARY FACADE

ENTRY ELEMENT PROJECTION HEIGHT (H) = 24- FEET
(H)15% = 3.6- FEET

PROJECTIONS HEIGHT (H) = 17.8- FEET
(H)15% = 2.6- FEET

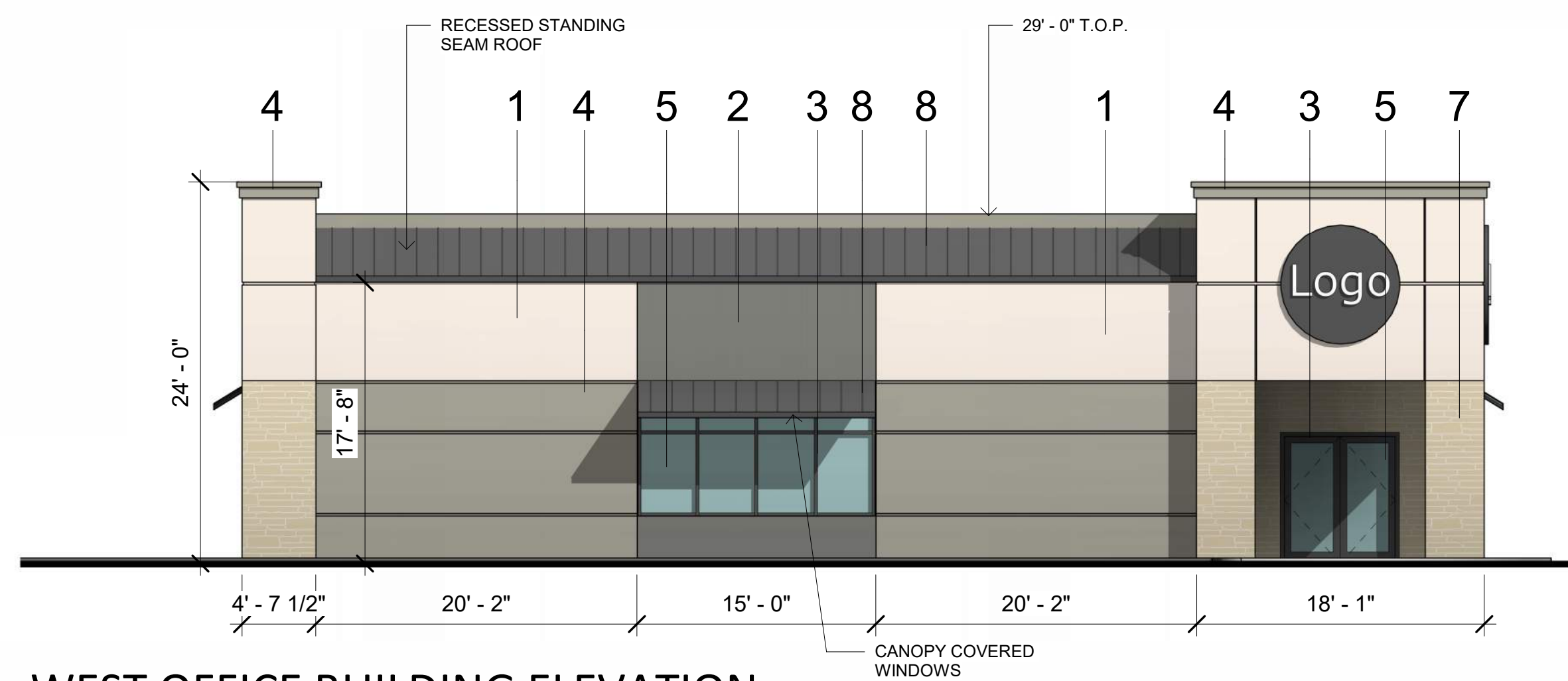

WEST OFFICE BUILDING ELEVATION

1/8" = 1'-0"

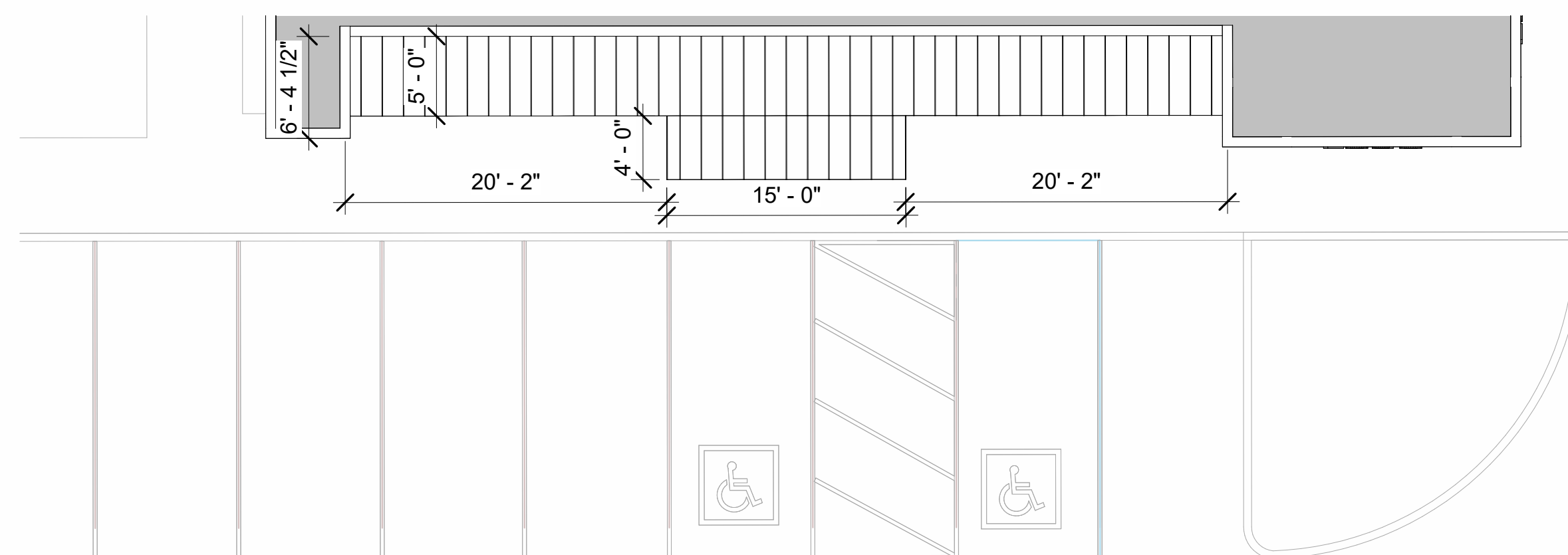

MATERIALS & COLORS:

- 1 - **STUCCO-PAINTED:**
MFG: DUNN-EDWARDS
COLOR: FRENCH WHITE
SPEC: DEW311
- 2 - **STUCCO-PAINTED:**
MFG: DUNN-EDWARDS
COLOR: STONE MASON
SPEC: DET615
- 3 - **PAINTED METAL:**
MFG: DUNN-EDWARDS
COLOR: CAVERNOUS
SPEC: DE6364
- 4 - **PAINTED STUCCO:**
MFG: DUNN-EDWARDS
COLOR: WHALE WATCHING
SPEC: DET512
- 5 - **GLAZING:**
MFG: SOLARBAN
COLOR: SOLARBAN 90(2) SOLARGRAY + CLEAR
VLT: 26%
- 6 - **STOREFRONT MULLIONS:**
MFG: KAWNEER
COLOR: DARK BRONZE
- 7 - **STONE VENEER:**
MFG: CORONADO
COLOR: CAP COD GRAY
- 8 - **METAL ROOF:**
MFG: ATAS
COLOR: CLASSIC BRONZE(01)

MATERIAL CALCULATIONS -

1 - FRENCH WHITE - 35.83%
2 - STONE MASON - 9.19%
4 - WHALE WATCHING - 37%
7 - STONE VENEER - 17.9%

NOTE:
BACKSIDE OF PARAPET TO BE FINISHED
THE SAME AS THE FRONT FACING FACADE

PRIMARY FACADE

ENTRY ELEMENT PROJECTION HEIGHT (H) = 24- FEET
(H)25% = 6- FEET

PROJECTIONS HEIGHT (H) = 17.8- FEET
(H)25% = 4.4- FEET



RKAA
2233 EAST THOMAS ROAD, PHOENIX, ARIZONA 85016
602-955-3900
RKAA.com

DATE: 10-01-2024

OFFICE - ELEVATIONS

NOTICE OF ALTERNATE BIDDING OR AWARDING CYCLE:
THIS CONTRACTOR MAY ALLOW THE OWNER TO REQUIRE
THE SUBMITTAL OF BIDDING OR AWARDING CYCLE
BIDDING CYCLES OTHER THAN THIRTY DAYS. THIS
CONTRACTOR MAY ALLOW THE OWNER TO MAKE PAYMENT
ON SOME ALTERNATE SCHEDULE AFTER
CONSTRUCTION AND APPROVAL OF BIDDING AND
ESTIMATES. A WRITTEN DESCRIPTION OF SUCH OTHER
BIDDING CYCLE APPLICABLE TO THE PROJECT IS
AVAILABLE FROM OWNER OR DESIGNATED AGENT.

NAME:
ADDRESS:
CONTACT:
PHONE:

5543 HORIZON ROAD ROCKWALL, TEXAS
(SCHEMATIC DESIGN)

COPYRIGHT 2024. ALL RIGHTS RESERVED. THIS
DRAWING IS A INSTRUMENT OF SERVICE. IT IS THE
PROPERTY OF ROBERT KIRKWOOD ARCHITECTS AND
ASSOCIATES, INC. AND MAY NOT BE REPRODUCED OR
REPRODUCTION OR USE, WITHOUT WRITTEN
PERMISSION OF THE CORPORATION.

DESIGN BY: KR
DRAWN BY: KR
CHECKED BY: NF

A2.2
PROJECT #: 24216.50



RKAA
2233 EAST THOMAS ROAD, PHOENIX, ARIZONA 85016
602-955-3900
RKAA.com

DATE: 10-01-2024

OFFICE - 3D VIEWS



NOTICE OF ALTERNATE BILLING OR PAYMENT CYCLE:
THIS CONTRACTOR MAY ALLOW THE OWNER TO REQUIRE
THE SUBMISSION OF BILLING OR ESTIMATES IN
BILLING CYCLES OTHER THAN THIRTY DAYS. THE
CONTRACTOR MAY ALLOW OWNERS TO MAKE PAYMENT
ON SOME ALTERNATE SCHEDULE AFTER
CONSULTATION AND APPROVAL OF BILLING AND
ESTIMATES. A WRITTEN DESCRIPTION OF SUCH OTHER
BILLING CYCLE APPLICABLE TO THE PROJECT IS
AVAILABLE FROM OWNER OR DESIGNATED AGENT.
NAME:
ADDRESS:
CONTACT:
PHONE:



5543 HORIZON ROAD ROCKWALL, TEXAS
(SCHEMATIC DESIGN)

COPYRIGHT 2024. ALL RIGHTS RESERVED. THIS
DRAWING IS A INSTRUMENT OF SERVICE. IT IS THE
PROPERTY OF ROBERT KUBACKI ARCHITECTS AND
ASSOCIATES, INC. AND MAY NOT BE REPRODUCED OR
REPRODUCTION FOR ANY USES WITHOUT WRITTEN
PERMISSION OF THE CORPORATION.

DESIGN BY: KR
DRAWN BY: KR
CHECKED BY: NF

A2.3
PROJECT #: 24216.50

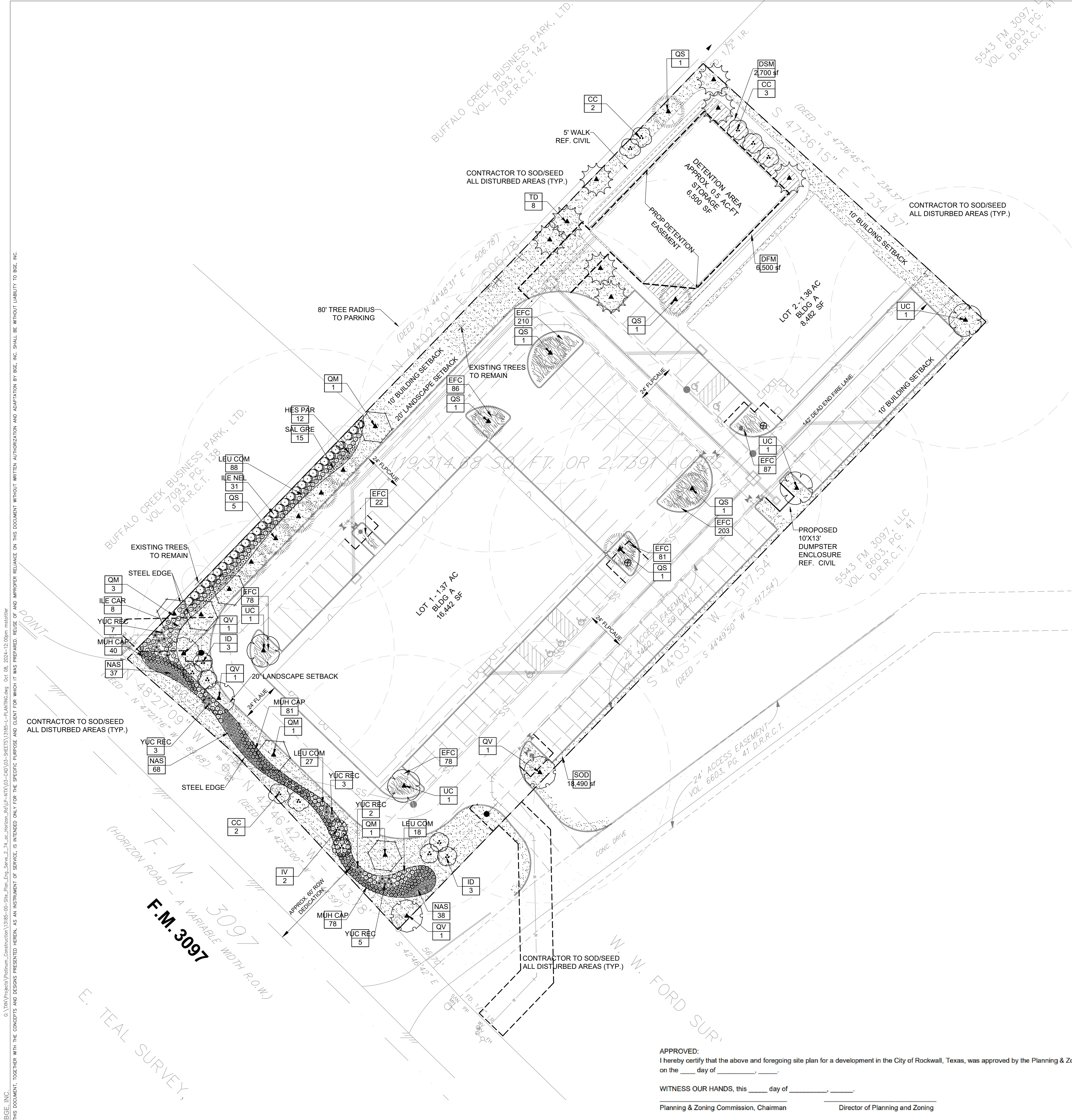

PLANT SCHEDULE

SYMBOL	CODE	BOTANICAL NAME	COMMON NAME
CANOPY TREES			
	QM	Quercus macrocarpa	Burr Oak
	QS	Quercus shumardii	Shumard Red Oak
	QV	Quercus virginiana	Southern Live Oak
	TD	Taxodium distichum	Bald Cypress
	UC	Ulmus crassifolia	Cedar Elm
ORNAMENTAL TREES			
	CC	Cercis canadensis	Eastern Redbud
	ID	Ilex decidua	Possumhaw Holly
	IV	Ilex vomitoria	Yaupon Holly
SHRUBS			
	HES PAR	Hesperaloe parviflora	Red Yucca
	ILE CAR	Ilex cornuta 'Carissa'	Carissa Holly
	ILE NEL	Ilex x 'Nellie R. Stevens'	Nellie R. Stevens Holly
	LEU COM	Leucophyllum frutescens 'Compacta'	Compact Texas Sage
	SAL GRE	Salvia greggii	Autumn Sage
	YUC REC	Yucca recurvifolia	Soft Leaf Yucca
GRASSES			
	MUH CAP	Muhlenbergia capillaris	Pink Muhly
	NAS	Nassella tenuissima	Mexican Feather Grass
GROUND COVER			
	EFC	Euonymus fortunei 'Coloratus'	Purple-leaf Winter Creeper
SEED			
	DSM		Dam Slope Mix
	DFM		Drainfield Mix
SOD			
	SOD	Cynodon dactylon	Tif Tuf Bermuda Grass
MISC			
	STEEL EDGE	TBD	Steel Edging
	MULCH	TBD	Shredded Hardwood Mulch

NOTE: PLANT QUANTITIES ARE PROVIDED FOR CONVENIENCE ONLY. IN THE CASE OF A DISCREPANCY, THE DRAWING SHALL TAKE PRECEDENCE.

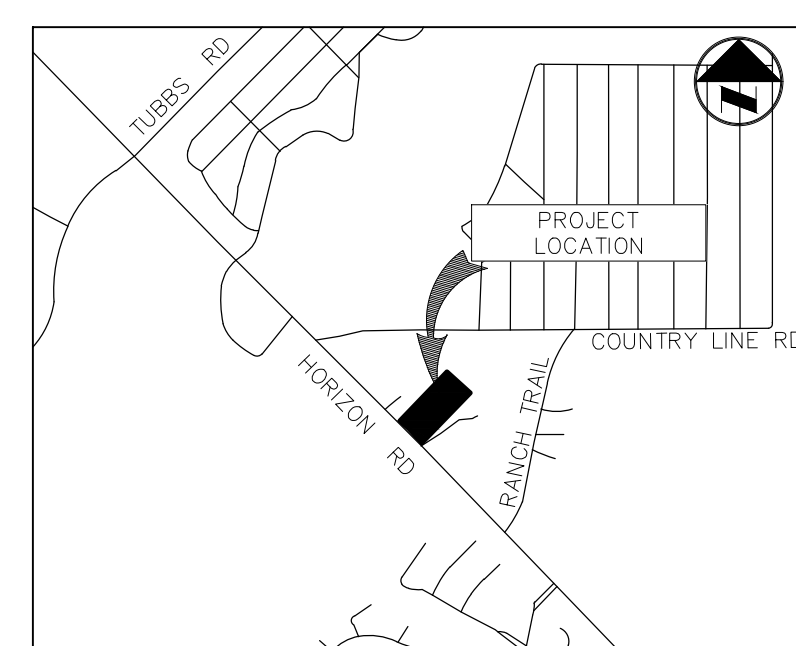

VICINITY MAP
(NOT TO SCALE)

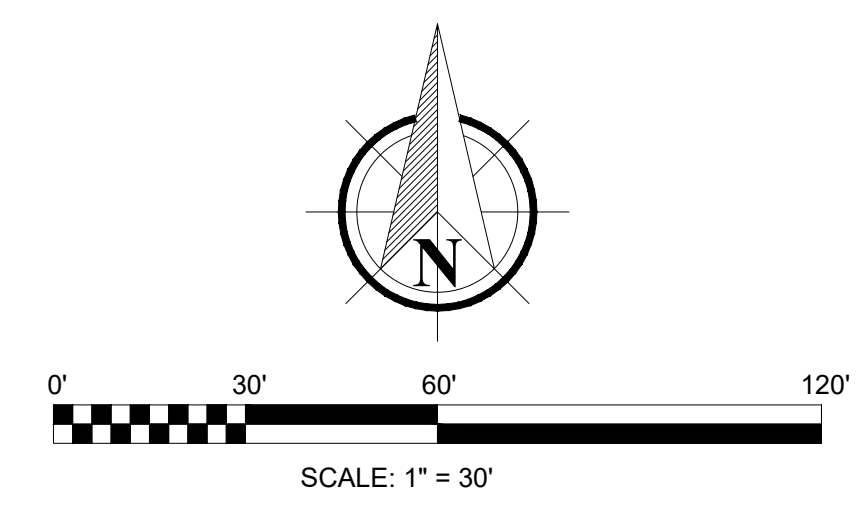

BGE, Inc.
2595 Dallas Parkway, Suite 101
Frisco, TX 75034
Tel: 972-464-4800 • www.bgeinc.com
TBPE Registration No. F-1046
Copyright 2024

DEVELOPER
PLATINUM CONSTRUCTION
1450 T L TOWNSEND DR. STE 100
ROCKWALL, TX 75032
TEL: (469) 222-1597
CONTACT: SHAWN VALK

OWNER
SARO PARTNERS LLC
1450 S. T L TOWNSEND
ROCKWALL, TX 75302
TEL: (000) 000-0000
CONTACT: JAY KANTER

CITY SUBMITTAL SET
PLANTING PLAN
HORIZON RD. COMMERCIAL OFFICES
W.W FORD SURVEY, ABSTRACT NO. 80, TRACT 26-4
CITY OF ROCKWALL, ROCKWALL COUNTY, TEXAS

THESE PLANS ARE ISSUED FOR THE PURPOSE OF PRELIMINARY REVIEW AND ARE NOT INTENDED FOR CONSTRUCTION. WHEN ISSUED IN FINAL FORM THEY WILL BE SEALED, SIGNED AND DATED.

RESPONSIBLE LANDSCAPE ARCHITECT:
MICHAEL STOTTLER, PLA
TEXAS REGISTRATION NO. 3743
BGE, INC.
REGISTERED ENGINEERING FIRM F-1046
10/8/2024

CAUTION!!
Contractor to Verify exact location & Depth of Exist Facilities Prior to any Construction Activities

CAUTION!!!
CONTACT: 1-800-DIG-TESS
48 HOURS PRIOR TO CONSTRUCTION

REVISIONS		
REV. NO.	DATE	DESCRIPTION

CHECKED BY: MLS
DESIGNED BY: NPS
DATE: 10/8/2024
PROJECT NUMBER: 13185-00

SHEET NO
L2.02
PLANTING PLAN

SITE PLAN
CASE NUMBER: SP2024-040
HORIZON ROAD COMMERCIAL OFFICES
2.7391 ACRES (119316 SF) BEING SITUATED IN
THE W.W FORD SURVEY, ABSTRACT NO. 80
CITY OF ROCKWALL, ROCKWALL COUNTY, TEXAS
SUBMITTED: SEPTEMBER 13, 2024
RESUBMITTED: OCTOBER 1, 2024

APPROVED:
I hereby certify that the above and foregoing site plan for a development in the City of Rockwall, Texas, was approved by the Planning & Zoning Commission of the City of Rockwall on the ____ day of ____.

WITNESS OUR HANDS, this ____ day of ____.

Planning & Zoning Commission, Chairman

Director of Planning and Zoning

BGE, INC. THE DOCUMENT, TOGETHER WITH THE CONCEPTS AND DESIGNS PRESENTED HEREIN, IS AN INSTRUMENT OF SERVICE. IT IS INTENDED ONLY FOR THE SPECIFIC PURPOSE AND CLIENT FOR WHICH IT WAS PREPARED. REUSE OF AND IMPROPER RELIANCE ON THIS DOCUMENT WITHOUT WRITTEN AUTHORIZATION AND ADAPTATION BY BGE, INC. SHALL BE WITHOUT LIABILITY TO BGE, INC.



BGE, Inc.
 2595 Dallas Parkway, Suite 101
 Frisco, TX 75034
 Tel: 972-464-4800 • www.bgeinc.com
 TBPE Registration No. F-1046
 Copyright 2024

DEVELOPER
PLATINUM CONSTRUCTION
 1450 TOWNSEND DR. STE 100
 ROCKWALL, TX 75032
 TEL: (469) 222-1597
 CONTACT: SHAWN VALK

OWNER
SARO PARTNERS LLC
 1450 S. T. L. TOWNSEND
 ROCKWALL, TX 75302
 TEL: (000) 000-0000
 CONTACT: JAY KANTER

CITY SUBMITTAL SET
PLANTING DETAILS
HORIZON RD. COMMERCIAL OFFICES
W.W FORD SURVEY, ABSTRACT NO. 80, TRACT
26-4
CITY OF ROCKWALL, ROCKWALL COUNTY, TEXAS

THESE PLANS ARE ISSUED FOR THE PURPOSE OF PRELIMINARY REVIEW AND ARE NOT INTENDED FOR CONSTRUCTION. WHEN ISSUED IN FINAL FORM THEY WILL BE SEALED, SIGNED AND DATED.

RESPONSIBLE LANDSCAPE ARCHITECT:
 MICHAEL STOTTLER, P.A.
 TEXAS REGISTRATION NO. 3743
 BGE, INC.
 TEXAS REGISTERED ENGINEERING FIRM F-1046
 10/8/2024

CAUTION !!
 Contractor to Verify exact location & Depth of Exist Facilities Prior to any Construction Activities

CAUTION !!!
 CONTACT: 1-800-DIG-TESS
 48 HOURS PRIOR TO CONSTRUCTION

REVISIONS		
REV. NO.	DATE	DESCRIPTION

CHECKED BY: MLS
 DESIGNED BY: NPS
 DATE: 10/8/2024
 PROJECT NUMBER: 13185-00

SHEET NO
L2.03
 PLANTING DETAILS

SITE PLAN
CASE NUMBER: SP2024-040
HORIZON ROAD COMMERCIAL OFFICES
2.7391 ACRES (119316 SF.) BEING SITUATED IN
THE W.W FORD SURVEY, ABSTRACT NO. 80
CITY OF ROCKWALL, ROCKWALL COUNTY, TEXAS
 SUBMITTED: SEPTEMBER 13, 2024
 RESUBMITTED: OCTOBER 1, 2024

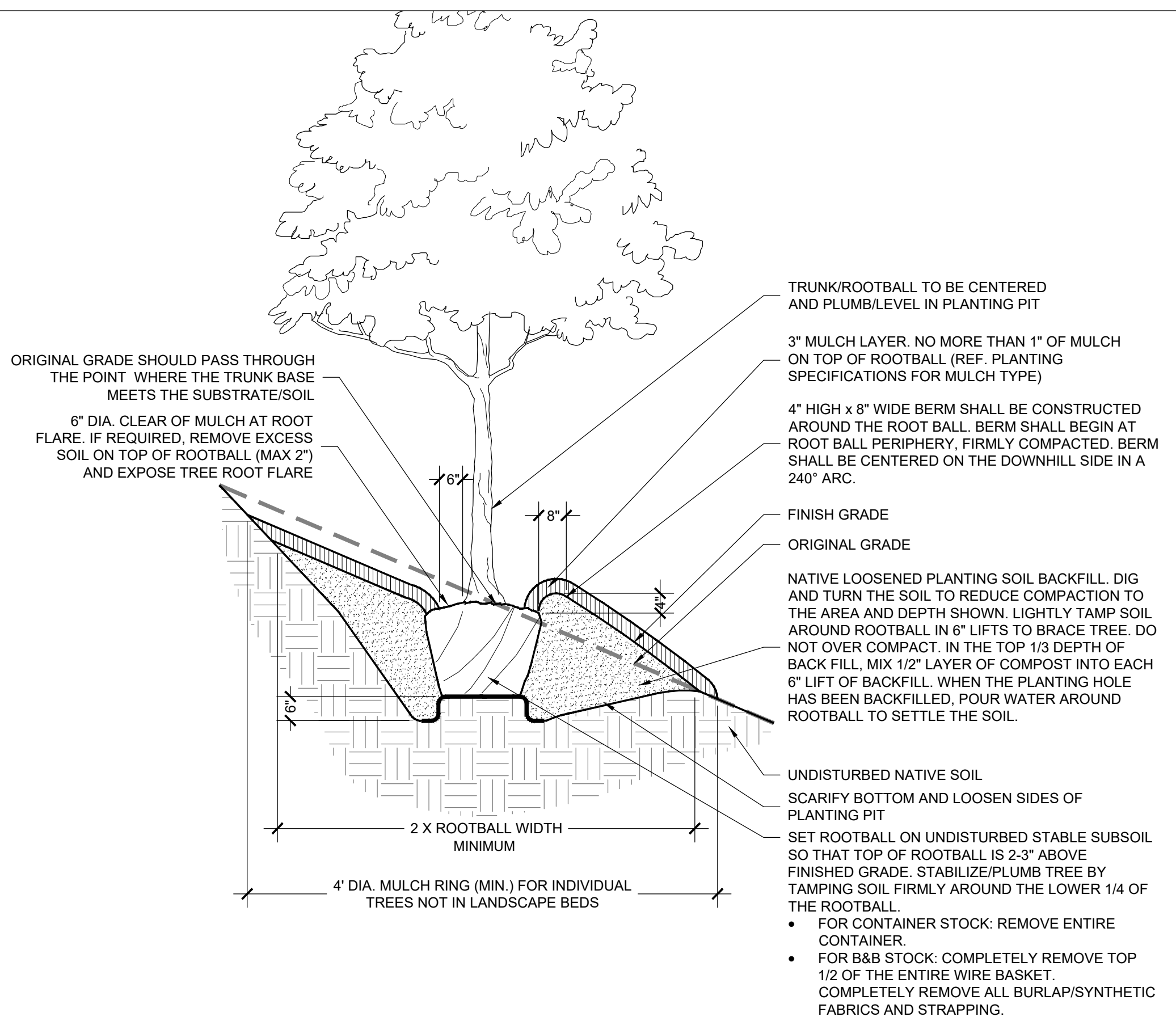

C TREE PLANTING ON 5-25% SLOPES (20:1 TO 4:1 SLOPES)
 SECTION NOT TO SCALE

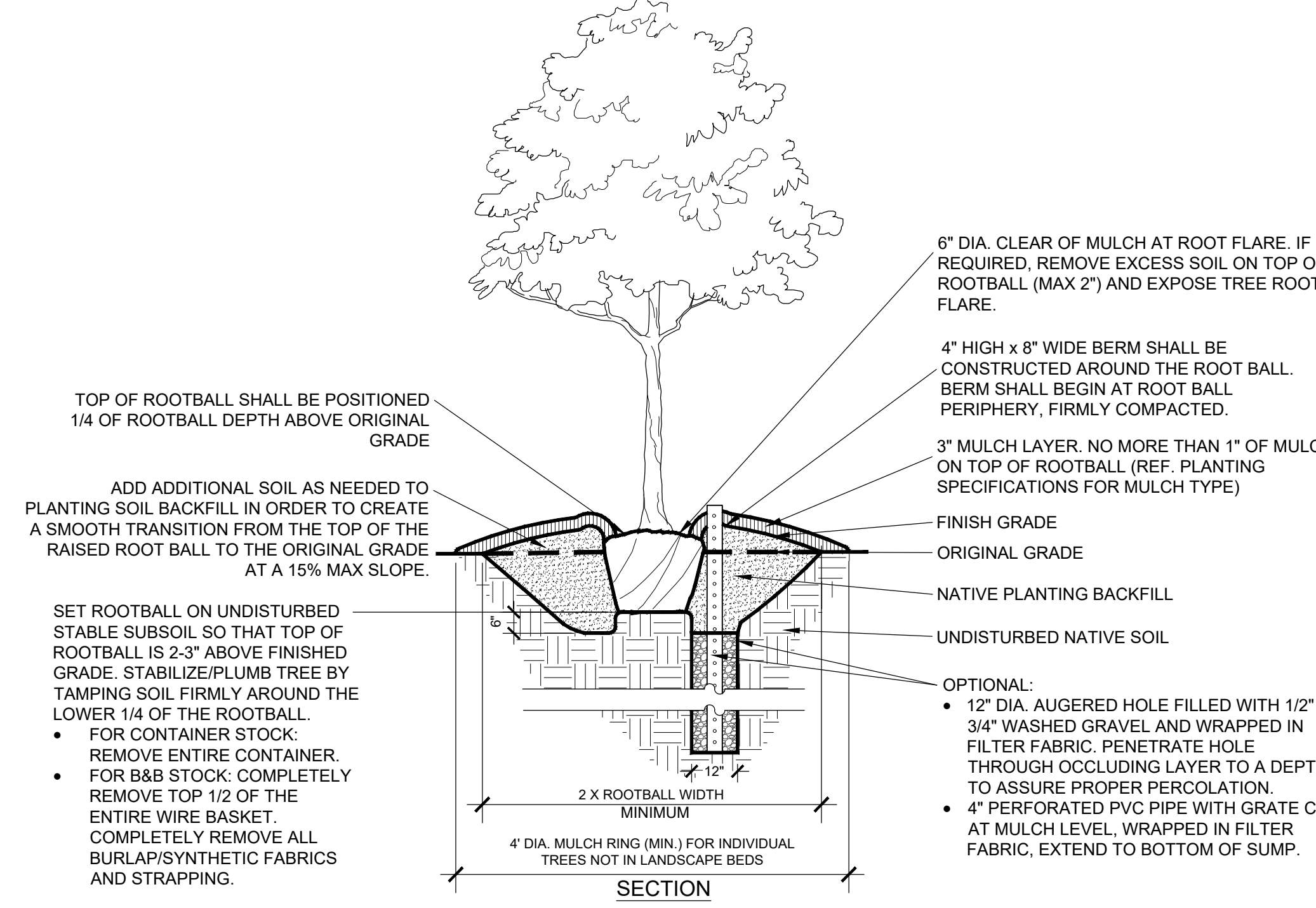
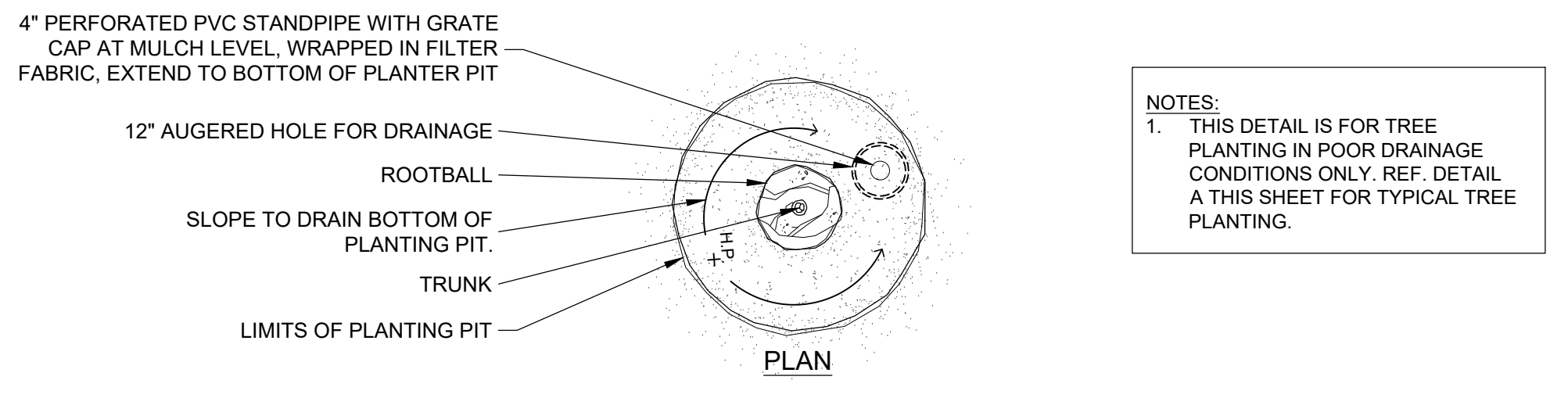

D PLANTING IN WET CONDITIONS
 SECTION/PLAN NOT TO SCALE

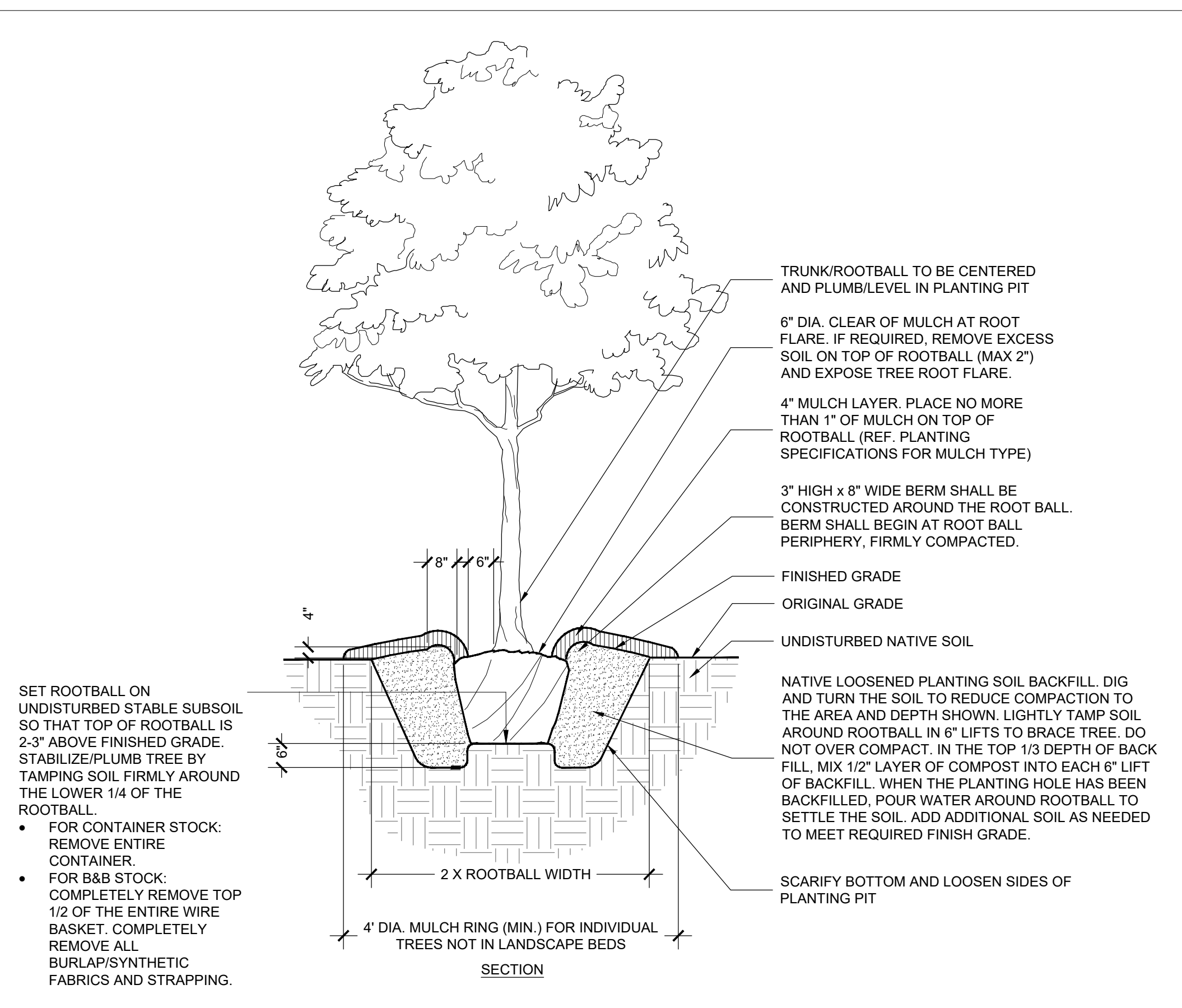

**A TYPICAL TREE PLANTING (UP TO 3\"/>
 SECTION NOT TO SCALE**

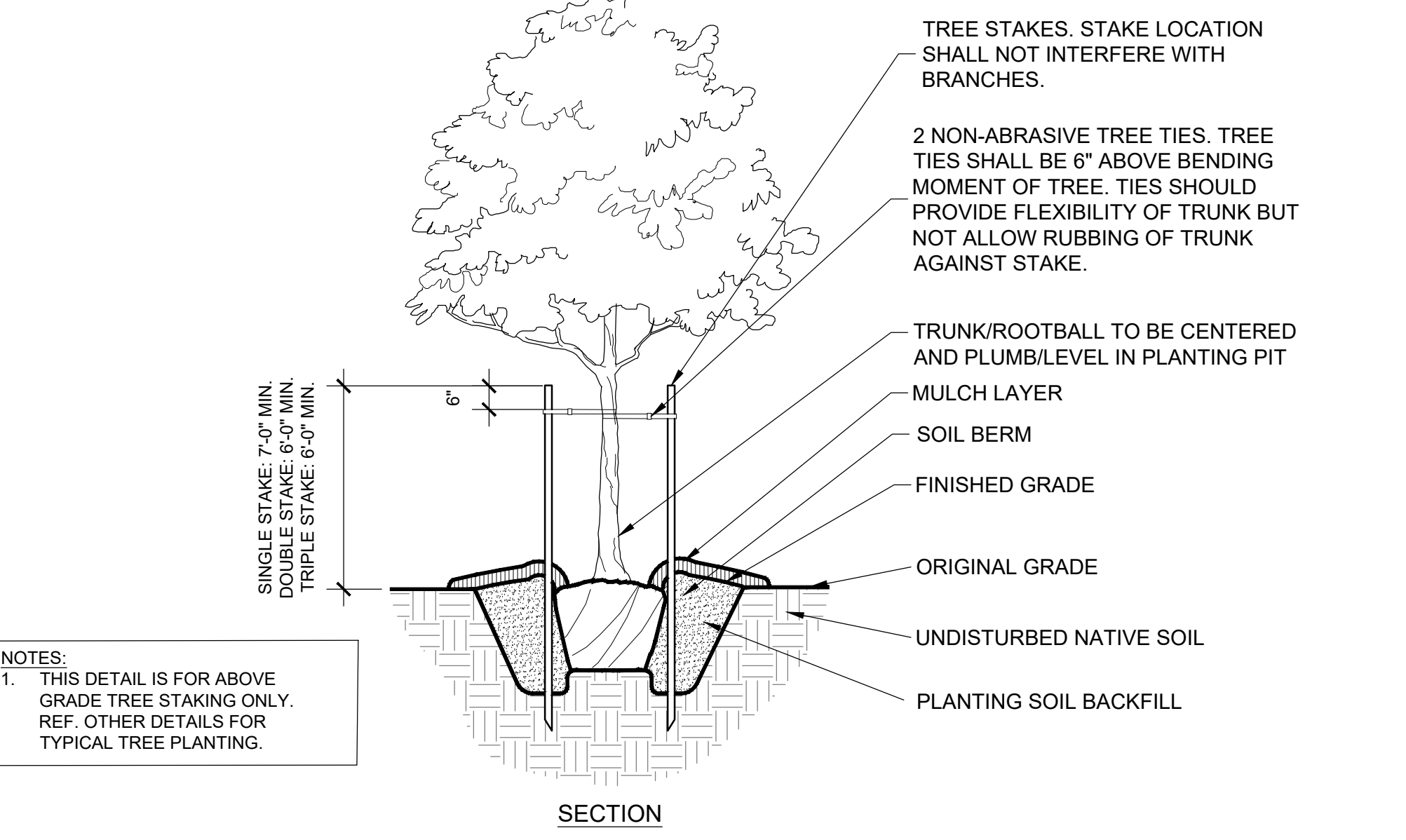
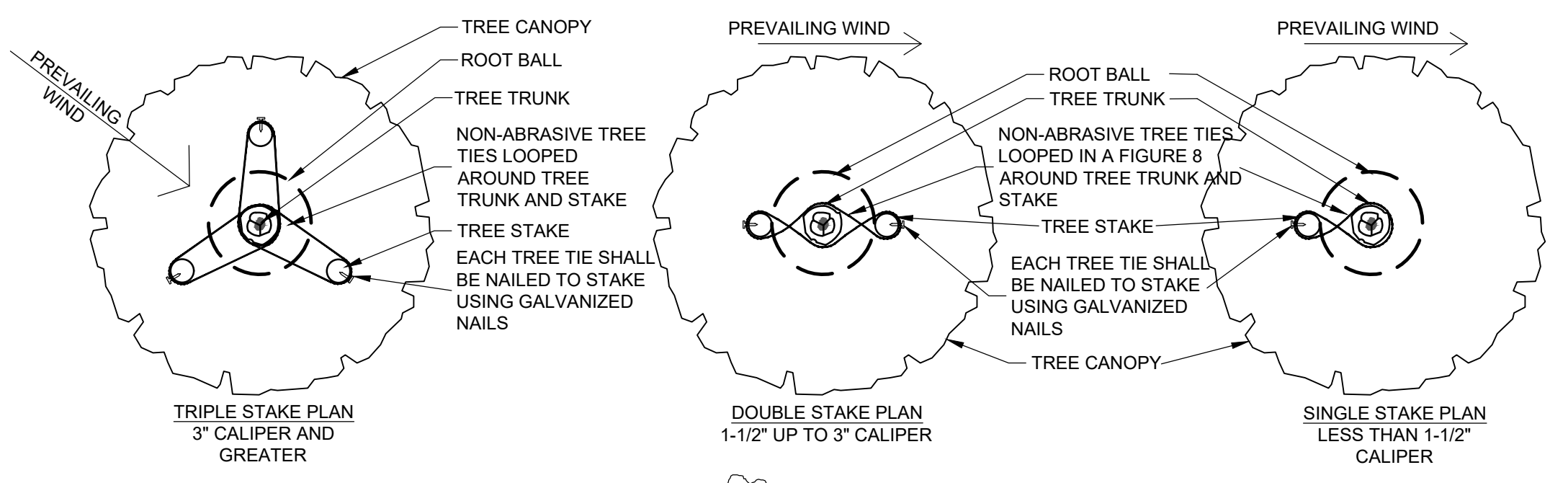

B TYPICAL TREE STAKING
 SECTION/PLAN NOT TO SCALE

APPROVED:
 I hereby certify that the above and foregoing site plan for a development in the City of Rockwall, Texas, was approved by the Planning & Zoning Commission of the City of Rockwall on the ____ day of ____.

WITNESS OUR HANDS, this ____ day of ____.

Planning & Zoning Commission, Chairman Director of Planning and Zoning

BGE, INC. THE DOCUMENT, TOGETHER WITH THE CONCEPTS AND DESIGNS PRESENTED HEREIN, IS AN INSTRUMENT OF SERVICE. © INTENDED ONLY FOR THE SPECIFIC PURPOSE AND CLIENT FOR WHICH IT WAS PREPARED. REUSE OF AND IMPROPER RELIANCE ON THIS DOCUMENT WITHOUT WRITTEN AUTHORIZATION AND ADAPTATION BY BGE, INC. SHALL BE WITHOUT LIABILITY TO BGE, INC.

BGE, INC. THE DOCUMENT, TOGETHER WITH THE CONCEPTS AND DESIGNS PRESENTED HEREIN, IS AN INSTRUMENT OF SERVICE. IT IS INTENDED ONLY FOR THE SPECIFIC PURPOSE AND CLIENT FOR WHICH IT WAS PREPARED. REUSE OF AND IMPROPER RELIANCE ON THIS DOCUMENT WITHOUT WRITTEN AUTHORIZATION AND ADAPTATION BY BGE, INC. SHALL BE WITHOUT LIABILITY TO BGE, INC. © 2024 BGE, INC. All Rights Reserved. 10/8/2024

1. REMOVE SUCKER SHOOTS AT BASE OF TREE.
 2. MAKE CLEAN CUTS ON OLD STUDS IF PRESENT.
 3. REMOVE ENTIRE SUPPLY OF TWIGS AND BUDS ON TRUNK.
 4. REMOVE LOWER BRANCH WHERE AN OVERLYING BRANCH OCCUPIES APPROX. SAME AREA.
 5. SHAPE TREE BY REMOVING INJURED AND MISSHAPED BRANCHES.
 6. REMOVE CROSS BRANCHES AND THOSE DEVELOPING INTO SECONDARY LEADERS.
 7. DO NOT REMOVE LEADER.
- NOTE: DASHED LINES INDICATE BRANCHES TO BE REMOVED. NO MORE THAN 20 PERCENT OF LIMBS, FOLIAGE, ETC., TO BE REMOVED, UNLESS NOTED OTHERWISE.

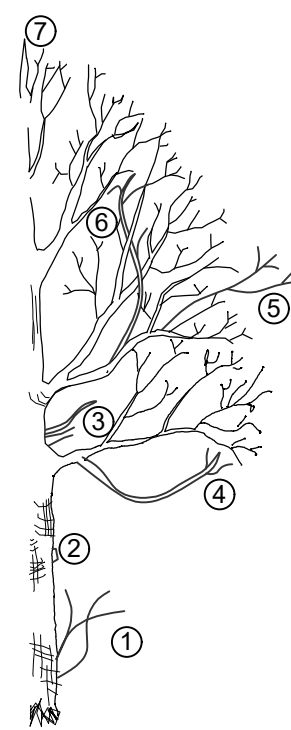

A SHADE TREE PRUNING
SECTION NOT TO SCALE

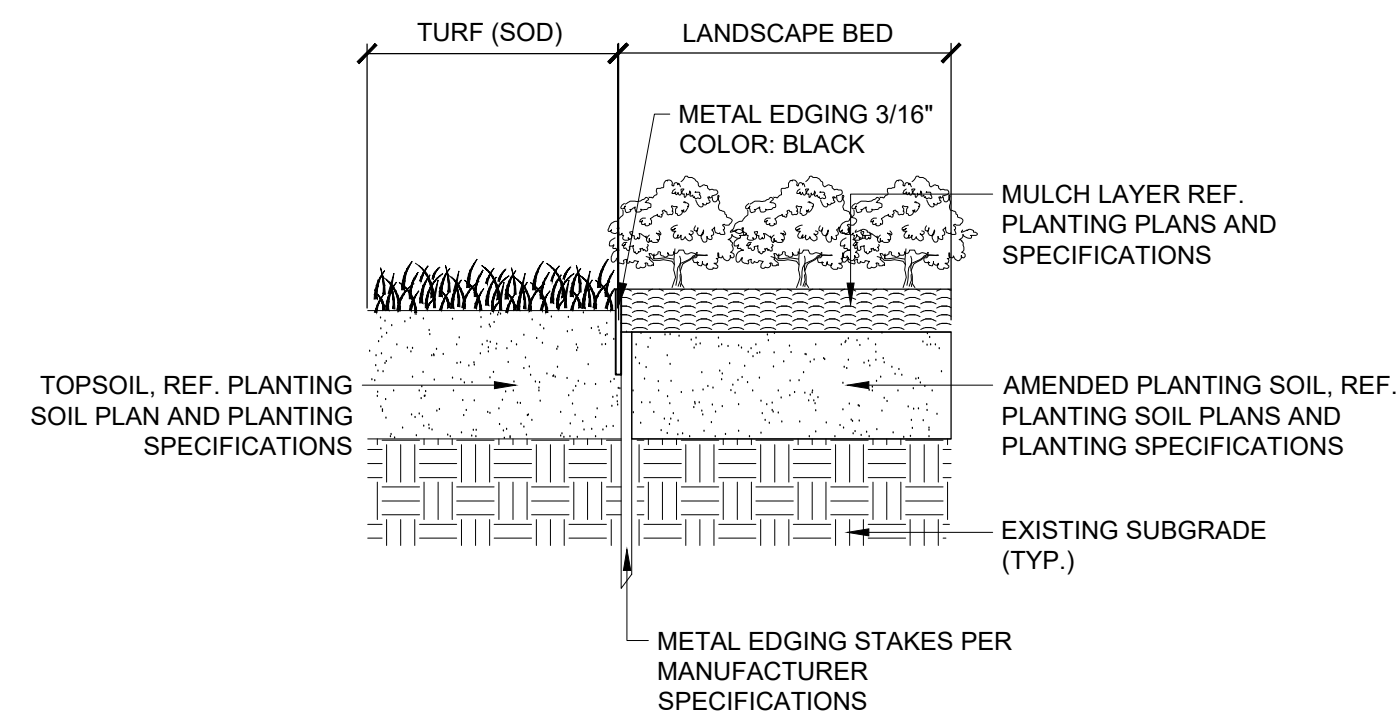

E STEEL EDGE
SECTION NOT TO SCALE

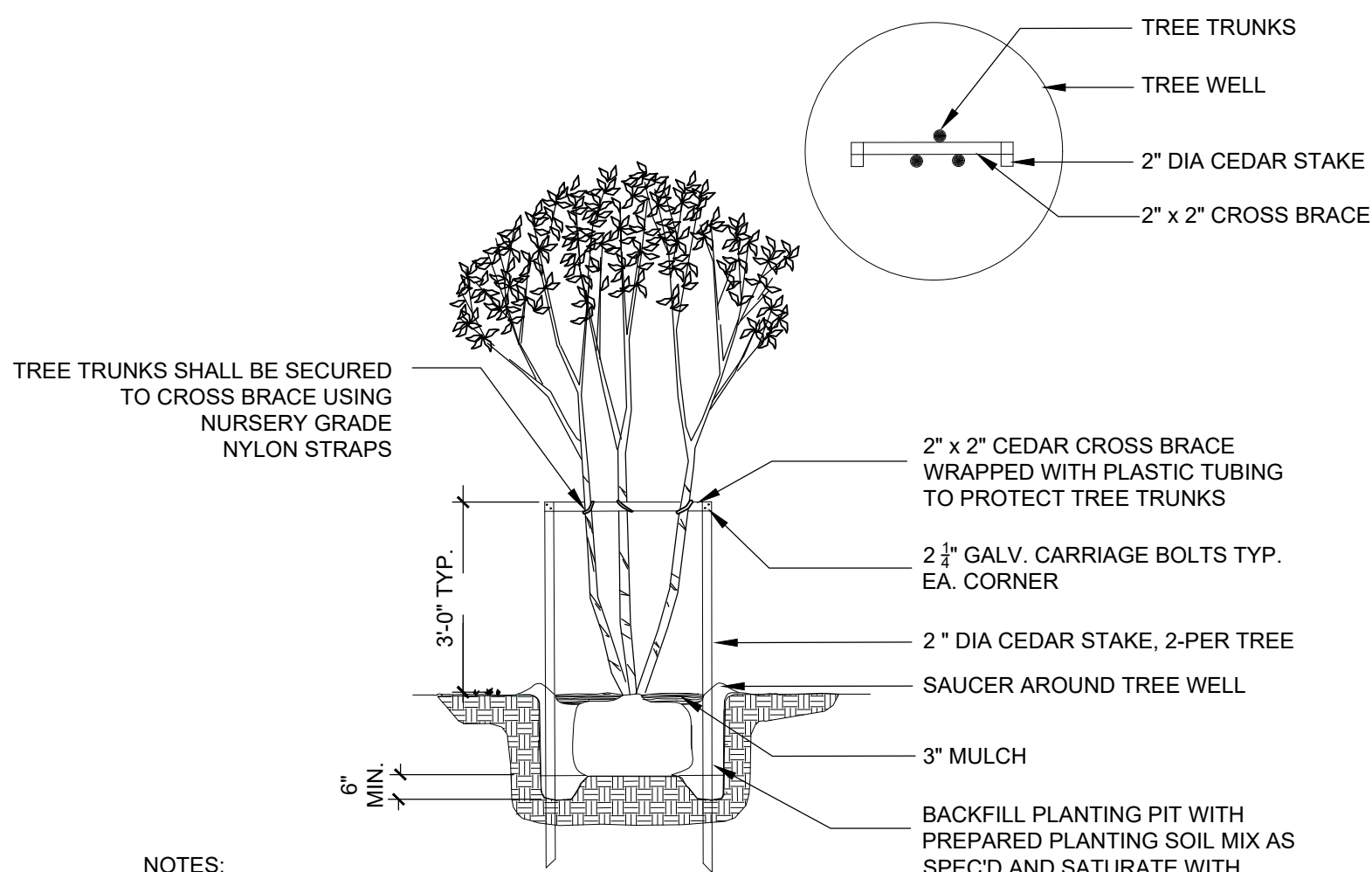

NOTES:
* TEMPORARY TREE WELL, STAKES AND CROSS BRACE TO BE REMOVED AFTER ONE FULL GROWING SEASON.
APPROXIMATELY 1/3 OF THE BRANCH STRUCTURE SHALL BE REMOVED BY THINNING BUT THE NATURAL CHARACTER AND GENERAL SHAPE OF THE TREE SHALL BE PRESERVED.

B ORNAMENTAL / MULTI-TRUNK TREE PLANTING
SECTION / ELEVATION NO TO SCALE

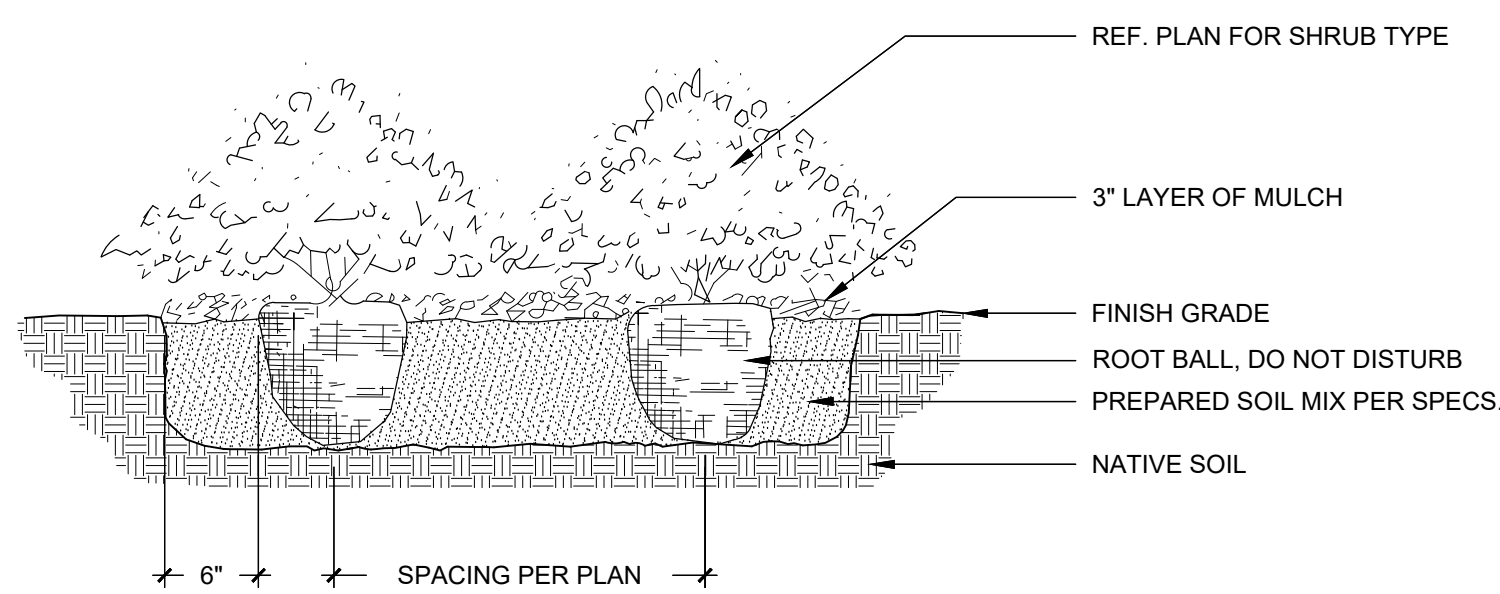

C SHRUB PLANTING
SECTION NO TO SCALE

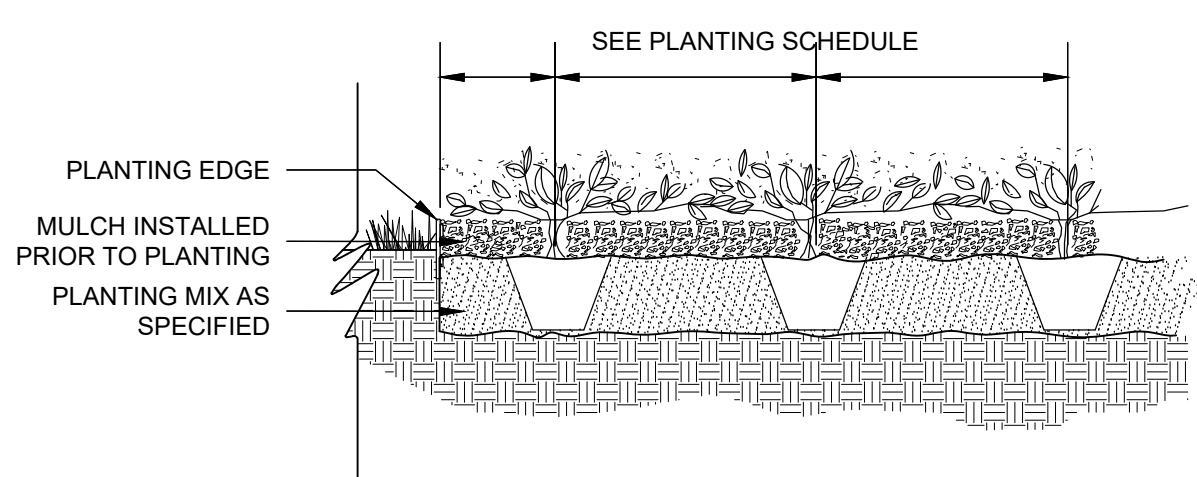

D GROUNDCOVER PLANTING
SECTION NOT TO SCALE

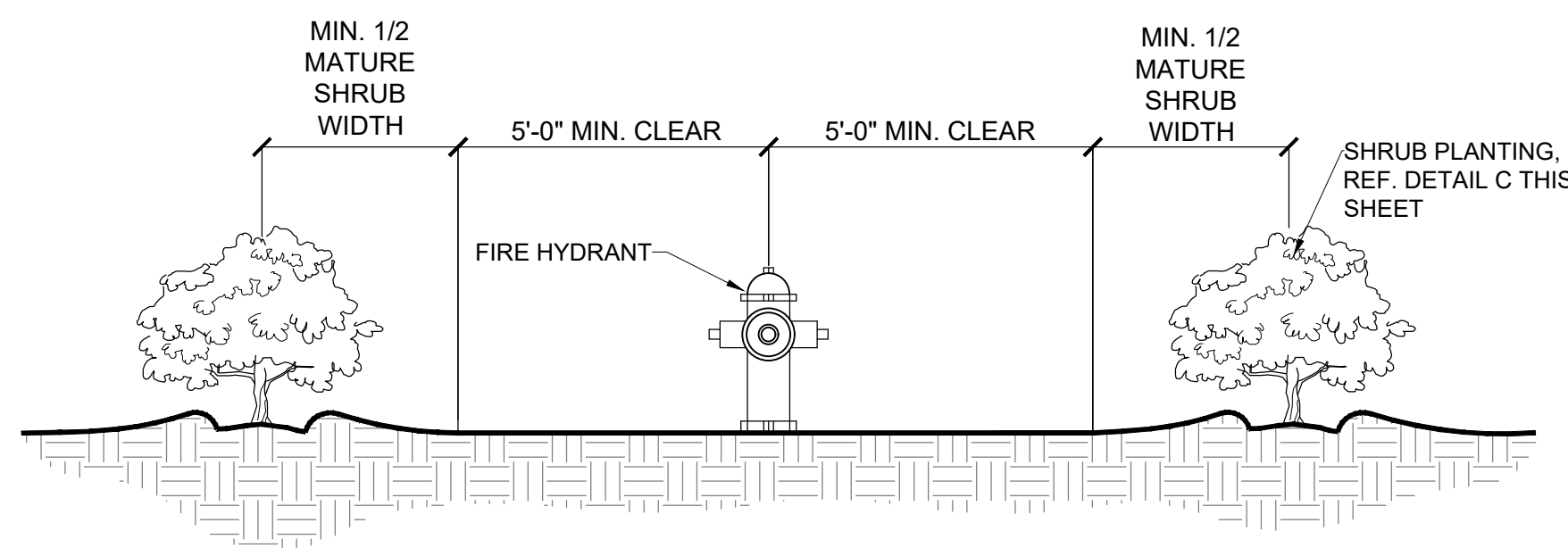

F PLANTING AT FIRE HYDRANT
SECTION NOT TO SCALE

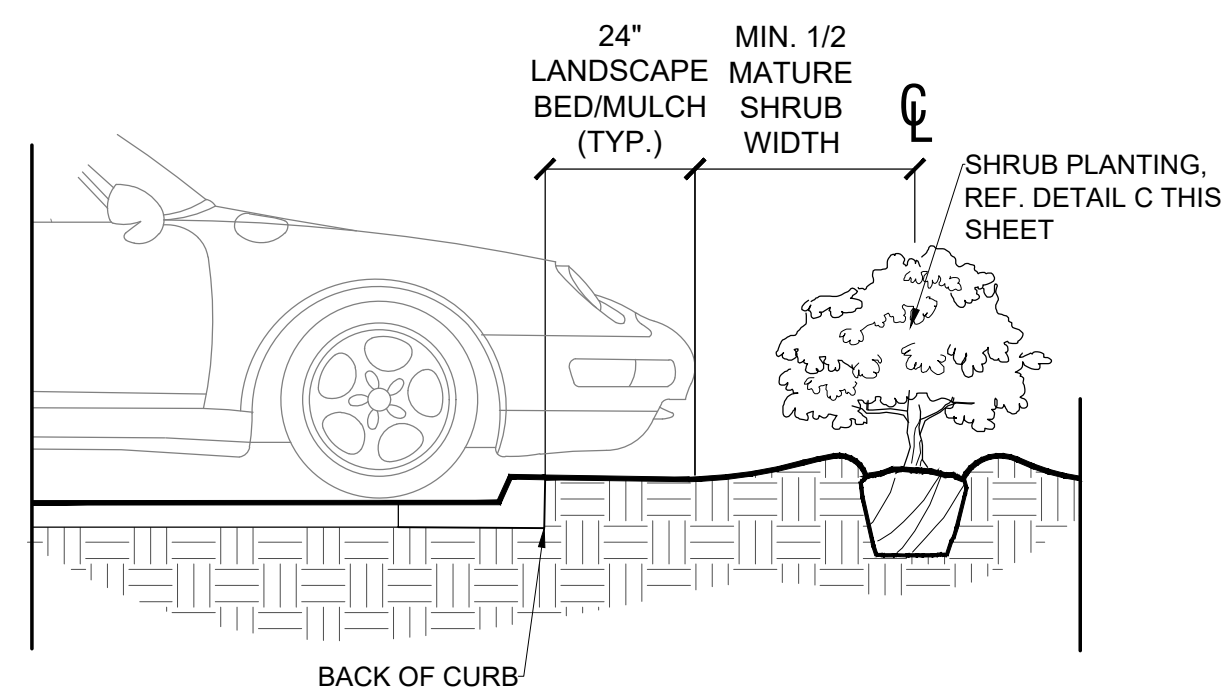
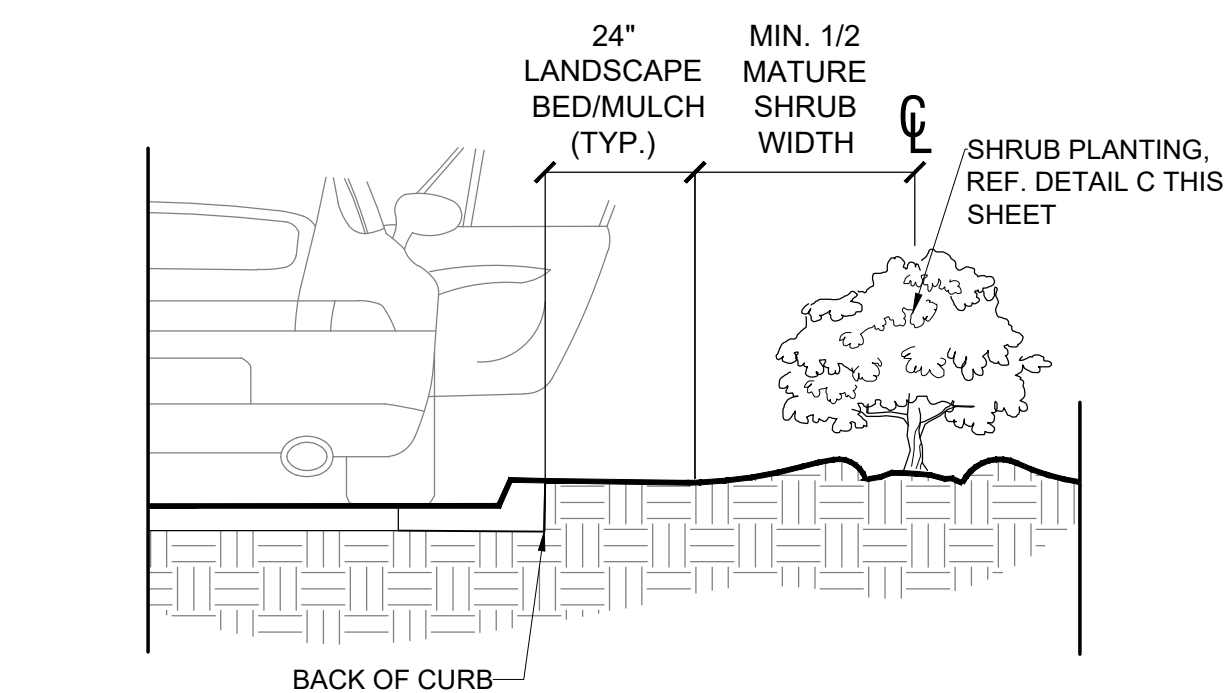

G PLANTING AT CURB
SECTION NOT TO SCALE

APPROVED:
I hereby certify that the above and foregoing site plan for a development in the City of Rockwall, Texas, was approved by the Planning & Zoning Commission of the City of Rockwall on the ____ day of ____.

WITNESS OUR HANDS, this ____ day of ____.

Planning & Zoning Commission, Chairman

Director of Planning and Zoning

SITE PLAN
CASE NUMBER: SP2024-040
HORIZON ROAD COMMERCIAL OFFICES
2.7391 ACRES (119316 SF.) BEING SITUATED IN
THE W.W FORD SURVEY, ABSTRACT NO. 80
CITY OF ROCKWALL, ROCKWALL COUNTY, TEXAS
SUBMITTED: SEPTEMBER 13, 2024
RESUBMITTED: OCTOBER 1, 2024



BGE, Inc.
2595 Dallas Parkway, Suite 101
Frisco, TX 75034
Tel: 972-464-4800 • www.bgeinc.com
TBPE Registration No. F-1046
Copyright 2024

DEVELOPER
PLATINUM CONSTRUCTION
1450 TL TOWNSEND DR. STE 100
ROCKWALL, TX 75032
TEL: (469) 222-1597
CONTACT: SHAWN VALK

OWNER
SARO PARTNERS LLC
1450 S. T L TOWNSEND
ROCKWALL, TX 75302
TEL: (000) 000-0000
CONTACT: JAY KANTER

CITY SUBMITTAL SET
PLANTING DETAILS
HORIZON RD. COMMERCIAL OFFICES
W.W FORD SURVEY, ABSTRACT NO. 80, TRACT
26-4
CITY OF ROCKWALL, ROCKWALL COUNTY, TEXAS

THESE PLANS ARE ISSUED FOR THE PURPOSE OF PRELIMINARY REVIEW AND ARE NOT INTENDED FOR CONSTRUCTION. WHEN ISSUED IN FINAL FORM THEY WILL BE SEALED, SIGNED AND DATED.

RESPONSIBLE LANDSCAPE ARCHITECT:
MICHAEL STOTTLER, PLA
TEXAS REGISTRATION NO. 3743
BGE, INC.
REGISTERED ENGINEERING FIRM F-1046
10/8/2024

!CAUTION!
Contractor to Verify exact location & Depth of Exist Facilities Prior to any Construction Activities

CAUTION!!!
CONTACT: 1-800-DIG-TESS
48 HOURS PRIOR TO CONSTRUCTION

REVISIONS		
REV. NO.	DATE	DESCRIPTION

CHECKED BY: MLS
DESIGNED BY: NPS
DATE: 10/8/2024
PROJECT NUMBER: 13185-00

SHEET NO
L2.04

PLANTING DETAILS

GENERAL LANDSCAPE SPECIFICATIONS AND NOTES

A. SCOPE OF WORK

1. THE WORK CONSISTS OF FURNISHING ALL LABOR, MATERIALS, EQUIPMENT, TOOLS, TRANSPORTATION, AND ANY OTHER APPURTENANCES NECESSARY FOR THE COMPLETION OF THIS PROJECT AS SHOWN ON THE DRAWINGS, AS INCLUDED IN THE PLANT LIST, AND AS HEREIN SPECIFIED.
2. WORK SHALL INCLUDE MAINTENANCE AND WATERING OF ALL PLANTING AREAS OF THIS CONTRACT UNTIL CERTIFICATION OF ACCEPTABILITY BY THE OWNER.

B. PROTECTION OF EXISTING STRUCTURES

ALL EXISTING BUILDINGS, WALKS, WALLS, PAVING, PIPING, AND OTHER ITEMS OF CONSTRUCTION AND PLANTING ALREADY COMPLETED OR ESTABLISHED SHALL BE PROTECTED FROM DAMAGE BY THIS CONTRACTOR UNLESS OTHERWISE SPECIFIED. ALL DAMAGE RESULTING FROM NEGLIGENCE SHALL BE REPAIRED OR REPLACED TO THE SATISFACTION OF THE OWNER.

C. PROTECTION OF EXISTING PLANT MATERIALS OUTSIDE LIMIT OF WORK

THE CONTRACTOR SHALL BE RESPONSIBLE FOR ALL UNAUTHORIZED CUTTING OR DAMAGE OF TREES AND SHRUBS EXISTING OR OTHERWISE, CAUSED BY CARELESS OPERATION OF EQUIPMENT, STOCKPILING OF MATERIALS, ETC. THIS SHALL INCLUDE COMPACTION BY DRIVING OR PARKING INSIDE THE DRIP-LINE OR THE SPILLING OF OIL, GASOLINE, OR OTHER DELETERIOUS MATERIALS WITHIN THE DRIP-LINE. NO MATERIALS SHALL BE BURNED WHERE THE HEAT WILL DAMAGE ANY PLANT. TREES KILLED OR DAMAGED SO THAT THEY ARE MIS-SHAPEN AND/OR UNSIGHTLY SHALL BE REPLACED AT THE COST TO THE CONTRACTOR OF TWO HUNDRED DOLLARS (\$200) PER CALIPER INCH ON AN ESCALATING SCALE WHICH ADDS AN ADDITIONAL TWENTY (20) PERCENT PER INCH OVER FOUR (4) INCHES CALIPER AS FIXED AND AGREED LIQUIDATED DAMAGES. CALIPER SHALL BE MEASURED AT SIX (6) INCHES ABOVE GROUND LEVEL FOR TREES UP TO AND INCLUDING FOUR (4) INCHES IN CALIPER AND AT TWELVE (12) INCHES ABOVE GROUND LEVEL FOR TREES OVER FOUR (4) INCHES IN CALIPER.

D. MATERIALS

1. GENERAL

SAMPLES OF MATERIALS AS LISTED BELOW SHALL BE SUBMITTED FOR APPROVAL. ON THE SITE OR AS OTHERWISE DETERMINED BY THE OWNER. UPON APPROVAL OF SAMPLES, DELIVERY OF MATERIALS MAY BEGIN.

MATERIALS	SAMPLES
MULCH	ONE (1) CUBIC YARD
TOPSOIL	ONE (1) CUBIC YARD
PLANTS	ONE (1) OF EACH VARIETY

2. PLANT MATERIALS

A. PLANT SPECIES AND SIZE SHALL CONFORM TO THOSE INDICATED ON THE DRAWINGS. NOMENCLATURE TO STANDARDIZED PLANT NAMES. 1. ALL NURSERY STOCK SHALL BE IN ACCORDANCE WITH GRADES AND STANDARDS AS STATED IN THE LATEST EDITION OF "AMERICAN STANDARD FOR NURSERY STOCK" BY THE AMERICAN ASSOCIATION OF NURSERYMEN. ALL PLANTS SHALL BE FRESHLY DUG, SOUND, HEALTHY, VIGOROUS, WELL-BRANCHED AND FREE OF DISEASE AND INSECTS, INSECT EGGS AND LARVAE AND SHALL HAVE ADEQUATE ROOT SYSTEMS. TREES FOR PLANTING IN ROWS SHALL BE UNIFORM IN SIZE AND SHAPE. ALL MATERIALS SHALL BE SUBJECT TO APPROVAL BY THE OWNER. WHERE ANY REQUIREMENTS ARE OMITTED FROM THE PLANT LIST, THE PLANTS FURNISHED SHALL BE NORMAL FOR THE VARIETY. PLANTS SHALL BE PRUNED PRIOR TO DELIVERY ONLY UPON THE APPROVAL OF THE OWNER.

B. MEASUREMENTS: THE HEIGHT AND/OR WIDTH OF TREES SHALL BE MEASURED FROM THE GROUND OR ACROSS THE NORMAL SPREAD OF BRANCHES WITH THE PLANTS IN THEIR NORMAL POSITION. THIS MEASUREMENT SHALL NOT INCLUDE THE IMMEDIATE TERMINAL GROWTH. PLANTS LARGER IN SIZE THAN THOSE SPECIFIED IN THE PLANT LIST MAY BE USED IF APPROVED BY THE OWNER. IF THE USE OF LARGER PLANTS IS APPROVED, THE BALL OF EARTH OR SPREAD OF ROOTS SHALL BE INCREASED IN PROPORTION TO THE SIZE OF THE PLANT.

C. INSPECTION: PLANTS SHALL BE SUBJECT TO INSPECTION AND APPROVAL AT THE PLACE OF GROWTH, OR UPON DELIVERY TO THE SITE, AS DETERMINED BY THE OWNER. FOR QUALITY, SIZE, AND VARIETY. SUCH APPROVAL SHALL NOT IMPAIR THE RIGHT OF INSPECTION AND REJECTION AT THE SITE DURING PROGRESS OF THE WORK OR AFTER COMPLETION FOR SIZE AND CONDITION OF BALLS OR ROOTS. LATENT DEFECTS OR INJURIES. REJECTED PLANTS SHALL BE REMOVED FROM THE SITE IMMEDIATELY FROM THE SITE. NOTICE REQUESTING INSPECTION SHALL BE SUBMITTED IN WRITING BY THE CONTRACTOR AT LEAST ONE (1) WEEK PRIOR TO ANTICIPATED DATE.

E. TOPSOIL

1. ASTM D5268, NATURAL, FRIABLE, FERTILE, FINE LOAMY SOIL POSSESSING CHARACTERISTICS OF REPRESENTATIVE TOPSOIL IN THE VICINITY THAT PRODUCES HEAVY GROWTH. TOPSOIL SHALL HAVE A PH RANGE OF 6.5 TO 7.4 PERCENT, FREE FROM SUBSOIL, OBJECTIONABLE WEEDS, LITTER, SODS, STIFF CLAY, STONES LARGER THAN 1-INCH IN DIAMETER, STUMPS, ROOTS, TRASH, HERBICIDES, TOXIC SUBSTANCES, OR ANY OTHER MATERIAL WHICH MAY BE HARMFUL TO PLANT GROWTH OR HINDER PLANTING OPERATIONS. TOP SOIL SHALL CONTAIN A MINIMUM OF THREE PERCENT ORGANIC MATERIAL.
2. SALVAGED OR EXISTING TOPSOIL: REUSE SUITABLE TOPSOIL STOCKPILED ON-SITE OR EXISTING TOPSOIL UNDISTURBED BY GRADING OR EXCAVATION OPERATIONS. CLEAN TOPSOIL OF ROOTS, PLANTS, SOD, STONES, CLAY LUMPS, AND OTHER EXTRANEOUS MATERIALS HARMFUL TO PLANT GROWTH.
3. VERIFY AMOUNT OF SUITABLE TOPSOIL STOCKPILED IF ANY, AND SUPPLY ADDITIONAL IMPORTED TOPSOIL AS NEEDED. FOUR (4) INCHES OF TOPSOIL TO BE PROVIDED FOR ALL TURF AREAS. TWENTY FOUR (24) INCHES OF TOPSOIL TO BE PROVIDED FOR ALL PLANTING AREAS WITHIN INTERIOR LANDSCAPE ISLANDS AND FOUNDATION PLANTINGS. FOR ALL OTHER PLANTING AREAS, TWELVE (12) INCHES OF TOPSOIL MINIMUM TO BE PROVIDED.
4. IMPORTED TOPSOIL: SUPPLEMENT SALVAGED TOPSOIL WITH IMPORTED TOPSOIL FROM OFF-SITE SOURCES WHEN EXISTING QUANTITIES ARE INSUFFICIENT.
5. OBTAIN TOPSOIL DISPLACED FROM NATURALLY WELL-DRAINED SITES WHERE TOPSOIL OCCURS AT LEAST 6 INCHES DEEP; DO NOT OBTAIN FROM AGRICULTURAL LAND, BOGS, OR MARSHES.
6. VERIFY BORROW AND DISPOSAL SITES ARE PERMITTED AS REQUIRED BY STATE AND LOCAL REGULATIONS. OBTAIN WRITTEN CONFIRMATION THAT PERMITS ARE CURRENT AND ACTIVE.
7. OBTAIN PERMITS REQUIRED BY STATE AND LOCAL REGULATIONS FOR TRANSPORTING TOPSOIL. PERMITS SHALL BE CURRENT AND ACTIVE.
8. AMEND EXISTING AND IMPORTED TOPSOIL AS INDICATED BELOW.
 - a. ORGANIC SOIL AMENDMENTS
 1. MANURE: WELL-ROTTED, UNLEACHED, STABLE OR CATTLE MANURE CONTAINING NOT MORE THAN 25 PERCENT BY VOLUME OF STRAW, SAND, LUST, OR OTHER BEDDING MATERIALS. FREE OF TOXIC SUBSTANCES, STONES, STICKS, SOIL, WEED SEED, AND MATERIAL HARMFUL TO PLANT GROWTH.
 2. BACK TO NATURE COTTON BURR COMPOST OR APPROVED EQUIVALENT.
 3. COMPOST: DECOMPOSED ORGANIC MATERIAL, INCLUDING LEAF LITTER, MANURE, SAWDUST, PLANT TRIMMINGS AND/OR HAY, MIXED WITH SOIL.
 4. PECAN HULLS: COMPOSTED PECAN HULLS FROM LOCAL SOURCE.
 5. BIOSOLIDS: USE GRADE 1 CONTAINING LOWER PATHOGEN LEVELS.
 6. WORM CASTINGS: EARTHWORMS.
 - b. INORGANIC SOIL AMENDMENTS
 1. LIME: ASTM C602, CLASS 0 AGRICULTURAL LIMESTONE CONTAINING A MINIMUM OF 90 PERCENT CALCIUM CARBONATE EQUIVALENT WITH A MINIMUM OF 95 PERCENT PASSING NO. 8 SIEVE AND MINIMUM OF 55 PERCENT PASSING NO. 60 SIEVE.
 2. SULFUR: GRANULAR, BIODEGRADABLE, CONTAINING A MINIMUM OF 90 PERCENT SULFUR, WITH A MINIMUM OF 99 PERCENT PASSING NO. 6 SIEVE AND A MAXIMUM OF 10 PERCENT PASSING NO. 40 SIEVE.
 3. IRON SULFATE: GRANULATED FERROUS SULFATE CONTAINING A MINIMUM OF 20 PERCENT IRON AND 10 PERCENT SULFUR.
 4. AGRICULTURAL GYPSUM: FINELY GROUND, CONTAINING A MINIMUM OF 90 PERCENT CALCIUM SULFATE.
 5. SAND: CLEAN, WASHED, NATURAL OR MANUFACTURED, FREE OF TOXIC MATERIALS.

c. PLANTING SOIL MIX

1. PLANTING MIX MAY BE PROVIDED BY LIVING EARTH OR MINICK MATERIALS OR APPROVED EQUAL.
2. PLANTING MEDIUM CONTAINING 75 PERCENT SPECIFIED TOPSOIL MIXED WITH 15 PERCENT ORGANIC SOIL AMENDMENTS AND 10 PERCENT SHARP WASHED SAND. TILL TO DEPTH OF 12" OR AS OTHERWISE NOTED. FINISHED GRADES OF PLANTING BEDS TO BE 2" BELOW FINISHED GRADE OF ADJACENT PAVING OR AS SHOWN ON GRADING PLAN.
2. SOD/SEED AREA TOPSOIL
ALL SOD AREAS TO RECEIVE 4" DEPTH (MIN) TOPSOIL. PRIOR TO INSTALLATION, TOPSOIL SHALL BE NATURAL, FRIABLE, FERTILE, WITH 25% (MIN.) ORGANIC MATERIAL, AND FREE OF TRASH, DEBRIS, STONES, WEEDS, AND TWIGS/BRANCHES. THE PARTICLE SIZES SHALL BE SUCH THAT 98.5% OF THE TOPSOIL WILL PASS THROUGH A 1/2 INCH SCREEN, AND 99% MORE SHALL PASS THROUGH A 3/8 INCH SCREEN. TOPSOIL SHALL BE REVIEWED/APPROVED BY OWNER/LANDSCAPE ARCHITECT PRIOR TO INSTALLATION. CONTRACTOR TO SUBMIT SAMPLES IN 1 GAL. (MIN.) CONTAINER.

I. WATER

WATER NECESSARY FOR PLANTING AND MAINTENANCE SHALL BE OF SATISFACTORY QUALITY TO SUSTAIN AN ADEQUATE GROWTH OF PLANTS AND SHALL NOT CONTAIN HARMFUL, NATURAL OR MAN-MADE ELEMENTS DETRIMENTAL TO PLANTS. WATER MEETING THE ABOVE STANDARD SHALL BE OBTAINED ON THE SITE FROM THE OWNER, IF AVAILABLE, AND THE CONTRACTOR SHALL BE RESPONSIBLE TO MAKE ARRANGEMENTS FOR ITS USE BY TANKS, HOSES, SPRINKLERS, ETC. IF SUCH WATER IS NOT AVAILABLE AT THE SITE, THE CONTRACTOR SHALL PROVIDE SUCH SATISFACTORY WATER FROM SOURCES OFF THE SITE AT NO ADDITIONAL COST TO THE OWNER.

J. COMMERCIAL FERTILIZER

COMMERCIAL FERTILIZER SHALL BE A COMPLETE FORMULA; IT SHALL BE UNIFORM IN COMPOSITION, DRY AND FREE FLOWING. THIS FERTILIZER SHALL BE DELIVERED TO THE SITE IN THE ORIGINAL UNOPENED CONTAINERS, EACH BEARING THE MANUFACTURER'S GUARANTEED STATEMENT OF ANALYSIS. FIFTY PERCENT (50%) OF THE NITROGEN SHALL BE DERIVED FROM NATURAL ORGANIC SOURCES. THE FOLLOWING FERTILIZERS SHALL BE USED AND APPLIED AT RATES AS SUGGESTED BY MANUFACTURER'S SPECIFICATIONS.

1. SHRUBS AND TREES - SUSTANE BLEND 16-4-8, OR APPROVED EQUAL.
2. ANNUALS AND GROUNDCOVERS - OSMOCOTE/SIERRA BLEND 14-14-14 OR APPROVED EQUAL.
3. SOD - 8-8-8 FERTILIZER OR APPROVED EQUAL.

K. MULCH

MULCH MATERIAL SHALL BE MOISTENED AT THE TIME OF APPLICATION TO PREVENT WIND DISPLACEMENT, AND APPLIED AT A DEPTH OF 3 INCHES. SEE PLANT LIST FOR TYPE OF MATERIAL AND GRADE.

L. DIGGING AND HANDLING

1. PROTECT ROOTS OR BALLS OF PLANTS AT ALL TIMES FROM SUN AND DRYING WINDS, WATER AND FREEZING, AS NECESSARY UNTIL PLANTING. PLANT MATERIALS SHALL BE ADEQUATELY PACKED TO PREVENT BREAKAGE AND DRYING OUT DURING TRANSIT. TREES TRANSPORTED MORE THAN TEN (10) MILES OR WHICH ARE NOT PLANTED WITHIN THREE (3) DAYS OF DELIVERY TO SITE SHALL BE SPRAYED WITH AN ANTI-TRANSPARENT PRODUCT ("WILTRUF" OR EQUAL) TO MINIMIZE TRANSPIRATIONAL WATER LOSS.
2. BALLED AND BURLAPPED PLANTS (8&8) SHALL BE DUG WITH FIRM, NATURAL BALLS OF SOIL OF SUFFICIENT SIZE TO ENCOMPASS THE FIBROUS AND FEEDING ROOTS OF THE PLANTS. NO PLANTS MOVED WITH A BALL SHALL BE PLANTED IF THE BALL IS CRACKED OR BROKEN. PLANTS BALLED AND BURLAPPED OR CONTAINER GROWN SHALL NOT BE HANDLED BY STEMS.
3. PLANTS MARKED "BR" IN THE PLANT LIST SHALL BE DUG WITH BARE ROOTS. THE ROOTS SHALL NOT BE CUT WITHIN THE MINIMUM SPREAD SPECIFIED IN THE PLANT LIST. CARE SHALL BE EXERCISED THAT THE ROOTS DO NOT DRY OUT IN MOVING AND PRIOR TO PLANTING.
4. PROTECTION OF PALMS (IF APPLICABLE): ONLY A MINIMUM OF FRONDS SHALL BE REMOVED FROM THE CROWN OF THE PALM TREE TO FACILITATE DOWING AND HANDLING. CLEAR TRUNK (CT) SHALL BE AS SPECIFIED AFTER THE MINIMUM OF FRONDS HAVE BEEN REMOVED. ALL PALMS SHALL BE BRACED PER DETAIL.
5. EXCAVATION OF TREE PITS SHALL BE DONE USING EXTREME CARE TO AVOID DAMAGE TO SURFACE AND SUBSURFACE ELEMENTS SUCH AS UTILITIES OR HARDSCAPE ELEMENTS, FOOTERS AND PREPARED SUB-BASES.

M. CONTAINER GROWN STOCK

1. ALL CONTAINER GROWN MATERIAL SHALL BE HEALTHY, VIGOROUS, WELL-ROOTED PLANTS AND ESTABLISHED IN THE CONTAINER IN WHICH THEY ARE SOLD. THE PLANTS SHALL HAVE TOPS WHICH ARE OF GOOD QUALITY AND ARE IN A HEALTHY GROWING CONDITION.
2. AN ESTABLISHED CONTAINER GROWN PLANT SHALL BE TRANSPLANTED INTO A CONTAINER AND GROWN IN THAT CONTAINER SUFFICIENTLY LONG FOR THE NEW FIBROUS ROOTS TO HAVE DEVELOPED SO THAT THE ROOT MASS WILL RETAIN ITS SHAPE AND HOLD TOGETHER WHEN REMOVED FROM THE CONTAINER. CONTAINER GROWN STOCK SHALL NOT BE HANDLED BY THEIR STEMS.
3. PLANT ROOTS BOUND IN CONTAINERS SHALL NOT BE ACCEPTABLE.
4. SUBSTITUTION OF NON-CONTAINER GROWN MATERIAL FOR MATERIAL EXPLICITLY SPECIFIED TO BE CONTAINER GROWN WILL NOT BE PERMITTED UNLESS WRITTEN APPROVAL IS OBTAINED FROM THE OWNER AND LANDSCAPE ARCHITECT.

N. COLLECTED STOCK

WHEN THE USE OF COLLECTED STOCK IS PERMITTED AS INDICATED ON THE PLANT LIST SCHEDULE, THE MINIMUM SIZES OF ROOTBALLS SHALL BE EQUAL TO THAT SPECIFIED FOR THE NEXT LARGER SIZE OF NURSERY GROWN STOCK OF THE SAME VARIETY.

O. NATIVE STOCK

PLANTS COLLECTED FROM WILD OR NATIVE STANDS SHALL BE CONSIDERED NURSERY GROWN WHEN THEY HAVE BEEN SUCCESSFULLY REESTABLISHED IN A NURSERY ROW AND GROWN UNDER REGULAR NURSERY CULTURAL PRACTICES FOR A MINIMUM OF TWO (2) GROWING SEASONS AND HAVE ATTAINED ADEQUATE ROOT AND TOP GROWTH TO INDICATE FULL RECOVERY FROM TRANSPANTING INTO THE NURSERY ROW.

P. MATERIALS LIST

QUANTITIES NECESSARY TO COMPLETE THE WORK ON THE DRAWINGS SHALL BE FURNISHED BY THE CONTRACTOR. QUANTITY ESTIMATES HAVE BEEN MADE CAREFULLY, BUT THE LANDSCAPE ARCHITECT OR OWNER ASSUMES NO LIABILITY FOR OMISSIONS OR ERRORS. SHOULD A DISCREPANCY OCCUR BETWEEN THE BIDDERS TAKE OFF AND THE PLANT LIST QUANTITIES, THE LANDSCAPE ARCHITECT SHALL BE NOTIFIED FOR CLARIFICATION PRIOR TO THE SUBMISSIONS OF BIDS. ALL DIMENSIONS AND/OR SIZES SPECIFIED SHALL BE THE MINIMUM ACCEPTABLE SIZE

Q. FINE GRADING

1. FINE GRADING UNDER THIS CONTRACT SHALL CONSIST OF FINAL FINISHED GRADING OF LAWN AND PLANTING AREAS THAT HAVE BEEN ROUGH GRADED BY OTHERS. BERMING AS SHOWN ON THE DRAWINGS SHALL BE THE RESPONSIBILITY OF THE LANDSCAPE CONTRACTOR, UNLESS OTHERWISE NOTED.
2. THE LANDSCAPE CONTRACTOR SHALL FINE GRADE THE LAWN AND PLANTING AREAS TO BRING THE ROUGH GRADE UP TO FINAL FINISHED GRADE ALLOWING FOR THICKNESS SOD AND/OR MULCH DEPTH. THIS CONTRACTOR SHALL FINE GRADE BY HAND AND/OR WITH ALL EQUIPMENT NECESSARY INCLUDING A GRADING TRACTOR WITH FRONT-END LOADER FOR TRANSPORTING SOIL WITHIN THE SITE.
3. ALL PLANTING AREAS SHALL BE GRADED AND MAINTAINED TO ALLOW FREE FLOW OF SURFACE WATER. AREAS ADJACENT TO BUILDINGS SHALL SLOPE AWAY FROM THE BUILDINGS.

R. PLANTING PROCEDURES

1. CLEANING UP BEFORE COMMENCING WORK: THE CONTRACTOR SHALL CLEAN UP JOB SITE AND SURROUNDING AREAS OF ALL RUBBISH OR OBJECTIONABLE MATTER. ALL MORTAR, CEMENT, AND TOXIC MATERIAL SHALL BE REMOVED FROM THE SURFACE OF ALL PLANT BEDS. THESE MATERIALS SHALL NOT BE MIXED WITH THE SOIL. SHOULD THE CONTRACTOR FIND SUCH CONDITIONS DURING EXCAVATION WHICH WILL IN ANY WAY ADVERSELY AFFECT THE PLANT GROWTH, HE SHALL IMMEDIATELY CALL IT TO THE ATTENTION OF THE LANDSCAPE ARCHITECT OR OWNER. FAILURE TO DO SO BEFORE PLANTING SHALL MAKE THE CORRECTIVE MEASURES THE RESPONSIBILITY OF THE CONTRACTOR.
2. VERIFY LOCATIONS OF ALL UTILITIES, CONDUITS, SUPPLY LINES AND CABLES, INCLUDING BUT NOT LIMITED TO: ELECTRIC, GAS LINES AND TANKS), WATER, SANITARY SEWER, STORMWATER LINES, CABLE AND TELEPHONE. PROPERLY MAINTAIN AND PROTECT EXISTING UTILITIES.
3. SUBGRADE EXCAVATION: SITE CONTRACTOR IS RESPONSIBLE TO REMOVE ALL EXISTING AND IMPORTED LIMEROCK AND LIMEROCK SUB-BASE FROM ALL LANDSCAPE PLANTING AREAS TO A MINIMUM DEPTH OF 36". SITE CONTRACTOR IS RESPONSIBLE TO BACKFILL THESE PLANTING AREAS TO ROUGH FINISHED GRADE WITH CLEAN TOPSOIL FROM AN ON-SITE SOURCE OR AN IMPORTED SOURCE. IF LIMEROCK OR OTHER ADVERSE CONDITIONS OCCUR IN PLANTED AREAS AFTER 36" DEEP EXCAVATION BY SITE CONTRACTOR, AND POSITIVE DRAINAGE CAN NOT BE ACHIEVED, LANDSCAPE CONTRACTOR SHALL CONTACT LANDSCAPE ARCHITECT OR OWNER.
4. FURNISH NURSERY'S CERTIFICATE OF COMPLIANCE WITH ALL REQUIREMENTS AS HEREIN SPECIFIED AND REQUIRED. INSPECT AND SELECT PLANT MATERIALS BEFORE PLANTS ARE DUG AT NURSERY OR GROWING SITE.

5. GENERAL: COMPLY WITH APPLICABLE FEDERAL, STATE, COUNTY, AND LOCAL REGULATIONS GOVERNING LANDSCAPE MATERIALS AND WORK. CONFORM TO ACCEPTED HORTICULTURAL PRACTICES AS USED IN THE TRADE. PLANTS SHALL BE PROTECTED FROM DAMAGE AT THE SITE BY BEING THOROUGHLY WATERED AND PROPERLY MAINTAINED UNTIL PLANTED. PLANTS SHALL NOT REMAIN UNPROTECTED FOR A PERIOD EXCEEDING TWENTY-FOUR (24) HOURS. AT ALL TIMES WORKMANLIKE METHODS CUSTOMARY IN GOOD HORTICULTURAL PRACTICES SHALL BE EXERCISED.

6. THE WORK SHALL BE COORDINATED WITH OTHER TRADES TO PREVENT CONFLICTS. COORDINATE THE PLANTING WITH THE IRRIGATION WORK TO ASSURE AVAILABILITY OF WATER AND PROPER LOCATION OF IRRIGATION ITEMS AND PLANTS.

7. ALL PLANTING PITS SHALL BE EXCAVATED TO SIZE AND DEPTH IN ACCORDANCE WITH THE USA STANDARD FOR NURSERY STOCK 260.1, UNLESS SHOWN OTHERWISE ON THE DRAWINGS, AND BACKFILLED WITH THE PREPARED PLANTING SOIL AS SPECIFIED HEREIN BEFORE (SECTION H). TEST ALL TREE PITS WITH WATER BEFORE PLANTING TO ASSURE PROPER PERCOLATION IS AVAILABLE. NO ALLOWANCE WILL BE MADE FOR LOST PLANTS DUE TO IMPROPER DRAINAGE. IF PROPER DRAINAGE EXISTS, UTILIZE PLANTING DEPTH THAT ADDRESSES THIS CONDITION. TREES SHALL BE SET PLUMB AND HELD IN POSITION UNTIL THE PLANTING MIXTURE HAS BEEN FLUSHED INTO PLACE WITH A SLOW, FULL HOSE STREAM. ALL PLANTING SHALL BE PERFORMED BY PERSONNEL FAMILIAR WITH PLANTING PROCEDURE AND UNDER THE SUPERVISION OF A QUALIFIED PLANTING FOREMAN. PROPER "JETTING IN" SHALL BE ASSURED TO ELIMINATE AIR POCKETS AROUND THE ROOTS. "JET STOP" OR EQUAL IS RECOMMENDED.

8. TAKE ALL NECESSARY PRECAUTIONS TO AVOID DAMAGE TO BUILDINGS AND BUILDING STRUCTURES WHILE INSTALLING TREES.

9. SOIL MIXTURE SHALL BE AS SPECIFIED IN SECTION H OF THESE SPECIFICATIONS. IN ADDITION, EACH PLANTING PIT SHALL RECEIVE 21-GRAM "AGRIFORM" PLANTING TABLETS PER MANUFACTURER'S SPECIFICATIONS OR AS FOLLOWS:

- TWO (2) TABLETS PER 1 GAL. PLANT
- THREE (3) TABLETS PER 3 GAL. PLANT
- FOUR (4) TABLETS PER 10 GAL. PLANT
- LARGER MATERIAL - TWO (2) TABLETS PER 1/2" OF TRUNK CALIPER

10. TREES AND SHRUBS SHALL BE SET STRAIGHT AND AT SUCH A LEVEL THAT AFTER SETTLEMENT, THE PLANT GROWN WILL STAND ONE (1) TO TWO (2) INCHES ABOVE GRADE. EACH PLANT SHALL BE SET IN THE CENTER OF THE PIT. PLANTING SOIL MIXTURE SHALL BE BACKFILLED AND THOROUGHLY TAMPED AROUND THE BALL AND SHALL BE SETTLED BY WATER AFTER TAMPING.

11. FILL HOLE WITH SOIL MIXTURE, MAKING CERTAIN ALL SOIL IS SATURATED. TO DO THIS, FILL HOLE WITH WATER AND ALLOW TO SOAK MINIMUM TWENTY (20) MINUTES, STIRRING IF NECESSARY TO GET SOIL THOROUGHLY WET. PACK LIGHTLY WITH FEET. ADD MORE WET SOIL MIXTURE. DO NOT COVER TOP OF BALL WITH SOIL MIXTURE. ONLY WITH MULCH. ALL BURLAP, ROPE, WIRES, ETC., SHALL BE REMOVED FROM THE SIDES AND TOPS OF BALLS, BUT NO BURLAP SHALL BE PULLED FROM UNDERNEATH.

12. PRUNING: EACH TREE SHALL BE PRUNED TO PRESERVE THE NATURAL CHARACTER OF THE PLANT AS SHOWN ON THE DRAWINGS. ALL SOFT WOOD OR SUCKER GROWTH AND ALL BROKEN OR BADLY DAMAGED BRANCHES SHALL BE REMOVED WITH A CLEAN CUT.

13. SHRUBS AND GROUND COVER PLANTS SHALL BE EVENLY SPACED IN ACCORDANCE WITH THE DRAWINGS AND AS INDICATED IN THE PLANT LIST. CULTIVATE ALL PLANTING AREAS TO A MINIMUM DEPTH OF 6"; REMOVE AND DISPOSE ALL DEBRIS. TILL INTO TOP 4" THE PLANTING SOIL MIX AS SPECIFIED IN SECTION E. THOROUGHLY WATER ALL PLANTS AFTER INSTALLATION.

14. TREE GUYING AND BRACING SHALL BE INSTALLED BY THE LANDSCAPE CONTRACTOR IN ACCORDANCE WITH THE PLANS TO INSURE STABILITY AND MAINTAIN TREES IN AN UPRIGHT POSITION. IF THE LANDSCAPE CONTRACTOR AND OWNER DECIDE TO WAIVE THE TREE GUYING AND BRACING, THE OWNER SHALL NOTIFY THE LANDSCAPE ARCHITECT IN WRITING OF THEIR INTENTIONS AND AGREE TO HOLD HARMLESS THE LANDSCAPE ARCHITECT IN THE EVENT ANY TREES FALL DOWN AND DAMAGE PERSON OR PROPERTY.

15. MULCHING: PROVIDE A THREE (3) INCH MINIMUM LAYER OF SPECIFIED MULCH OVER THE ENTIRE AREA OF EACH SHRUB BED, GROUND COVER, VINE BED, AND TREE PIT.

16. HERBICIDE WEED CONTROL: ALL PLANT BEDS SHALL BE KEPT FREE OF NOXIOUS WEEDS UNTIL FINAL ACCEPTANCE OF WORK. IF DIRECTED BY THE OWNER, AN APPROVED CHEMICAL HERBICIDE SHALL BE APPLIED FOR WEED CONTROL BY QUALIFIED PERSONNEL TO ALL PLANTING AREAS IN SPOT APPLICATIONS PER MANUFACTURER'S PRECAUTIONS AND SPECIFICATIONS. PRIOR TO FINAL INSPECTION, TREAT ALL PLANTING BEDS WITH AN APPROVED PRE-EMERGENT HERBICIDE AT AN APPLICATION RATE RECOMMENDED BY THE MANUFACTURER.

S. LAWN SODDING

1. THE WORK CONSISTS OF LAWN BED PREPARATION, SOIL PREPARATION, AND SODDING, IN STRICT ACCORDANCE WITH THE SPECIFICATIONS AND THE APPLICABLE DRAWINGS TO PRODUCE A GRASS LAWN ACCEPTABLE TO THE OWNER.

2. SOIL PREPARATION: PREPARE LOOSE BED FOUR (4) INCHES DEEP. APPLY FERTILIZER AT RATE OF TWENTY (20) POUNDS PER ONE THOUSAND (1000) SQUARE FEET. APPLICATION SHALL BE UNIFORM. UTILIZING APPROVED MECHANICAL SPREADERS, MIX FERTILIZER THOROUGHLY WITH THE SOIL TO A DEPTH OF THREE (3) INCHES. HAND RAKE UNTIL ALL BUMPS AND DEPRESSIONS ARE REMOVED. WET PREPARED AREA THOROUGHLY.

3. LAWN BED PREPARATION: ALL AREAS THAT ARE TO BE SODDED SHALL BE CLEARED OF ANY ROUGH GRASS, WEEDS, AND DEBRIS, AND THE GROUND BROUGHT TO AN EVEN GRADE. THE WHOLE SURFACE SHALL BE ROLLED WITH A ROLLER WEIGHING NOT MORE THAN ONE-HUNDRED (100) POUNDS PER SQUARE FOOT. DURING THE ROLLING, ALL DEPRESSIONS CAUSED BY SETTLEMENT OF ROLLING SHALL BE FILLED WITH ADDITIONAL SOIL, AND THE SURFACE SHALL BE REGRADED AND ROLLED UNTIL PRESENTING A SMOOTH AND EVEN FINISH THAT IS UP TO THE REQUIRED GRADE.

4. SODDING

A. THE CONTRACTOR SHALL SOD ALL AREAS THAT ARE NOT PAVED OR PLANTED AS DESIGNATED ON THE DRAWINGS WITHIN THE CONTRACT LIMITS, UNLESS SPECIFICALLY NOTED OTHERWISE.

B. THE SOD SHALL BE CERTIFIED TO MEET THE STATE PLANT BOARD SPECIFICATIONS, ABSOLUTELY TRUE TO VARIETAL TYPE, AND FREE FROM WEEDS, FUNGUS, INSECTS AND DISEASE OF ANY KIND.

C. SOD PANELS SHALL BE LAID TIGHTLY TOGETHER SO AS TO MAKE A SOLID SODDED LAWN AREA. SOD SHALL BE LAID UNIFORMLY AGAINST THE EDGES OF ALL CURBS AND OTHER HARDSCAPE ELEMENTS. PAVED OR PLANTED AREAS IMMEDIATELY FOLLOWING SOD LAYING, THE LAWN AREAS SHALL BE ROLLED WITH A LAWN ROLLER CUSTOMARILY USED FOR SUCH PURPOSES, AND THEN THOROUGHLY IRRIGATED. IF, IN THE OPINION OF THE OWNER, TOP-DRESSING IS NECESSARY AFTER ROLLING TO FILL THE VOIDS BETWEEN THE SOD PANELS AND TO EVEN OUT INCONSISTENCIES IN THE SOD, CLEAN SAND AS APPROVED BY THE LANDSCAPE ARCHITECT OR OWNER SHALL BE UNIFORMLY SPREAD OVER THE ENTIRE SURFACE OF THE SOD AND THOROUGHLY WATERED IN.

D. DURING DELIVERY, PRIOR TO AND DURING THE PLANTING OF THE LAWN AREAS, THE SOD PANELS SHALL AT ALL TIMES BE PROTECTED FROM EXCESSIVE DRYING AND UNNECESSARY EXPOSURE OF THE ROOTS TO THE SUN. ALL SOD SHALL BE STACKED SO AS NOT TO BE DAMAGED BY SWEATING OR EXCESSIVE HEAT AND MOISTURE.

5. SEEDING

1. PROVIDE FRESH, CLEAN, NEW CROP NATIVE GRASS AND/OR WILDFLOWER SEED MIXTURE IN SEALED CONTAINERS. FURNISH TO OWNER DEALER'S GUARANTEED STATEMENT OF COMPOSITION OF MIXTURE AND PERCENTAGE OF PURITY AND GERMINATION OF EACH VARIETY.

2. DRILL SEEDING

A. DRILL SEED OR BROADCAST SEED ALL NATIVE GRASS AND WILDFLOWER MIXES, AS DESIGNATED IN PLANTING PLANS. NO HYDROMULCHING OF NATIVE SEED MIXES.

B. BEGIN SEEDING IMMEDIATELY AFTER APPROVAL OF FINISHED GRADE. DO NOT PERFORM SEEDING IN WINDY CONDITIONS OR FOLLOWING RECENT RAINFALL EVENTS.

C. PERFORM SEEDING FROM EARLY SPRING TO LATE SUMMER WHEN SOIL TEMPERATURES ARE ABOVE 65 DEGREES FAHRENHEIT. WHEN SEEDING OPERATIONS OF THE PERMANENT NATIVE SEED VARIETIES SPECIFIED IN THE PLANS DO NOT FALL WITHIN THE SPECIFIED DATES, ANNUAL RYE GRASS WILL BE SEEDING AT A RATE OF 10 POUNDS PER 1,000 SQUARE FEET USING A NO-TILL DRILL SEEDER DESIGNED SPECIFICALLY FOR GRASS SEEDING. CONVERSION TO THE PERMANENT NATIVE SEED VARIETIES IS PART OF THIS SCOPE OF WORK AND WILL TAKE PLACE AS AND WHEN SPECIFIED.

D. APPLY NATIVE SEED AT THE RATE SPECIFIED BY THE DEALER. ALL SEED, SEED MIXES, AND FERTILIZER TO BE UNIFORMLY APPLIED AT THE SPECIFIED RATE. AMOUNT WILL VARY BASED ON RATE OF SEEDING. SEED SHALL BE DRILLED AT A DEPTH FROM ONE-QUARTER INCH (1/4") TO THREE-EIGHTHS INCHES (3/8") UTILIZING A NO-TILL DRILL SEEDER DESIGNED SPECIFICALLY FOR GRASS SEEDING. ALL DRILLING IS TO BE DONE ON CONTOUR.

E. CULTI-PACKER OR APPROVED SIMILAR EQUIPMENT MAY BE USED TO COVER SEED AND TO FORM SEEDBED IN ONE OPERATION. IN AREAS INACCESSIBLE TO CULTI-PACKER, LIGHTLY RAKE SEEDED GROUND WITH FLEXIBLE RAKES AND ROLL WITH WATER BALLAST ROLLER. AFTER ROLLING, MULCH WITH STRAW MULCH AT THE RATE OF 2 TONS PER ACRE. ALL ROLLING TO BE DONE ON CONTOUR. DO NOT SEED AREAS IN EXCESS OF WHAT CAN BE ROLLED ON THE SAME DAY.

F. SURFACE LAYER OF SOIL FOR SEEDING AREAS SHALL BE KEPT MOIST DURING THE GERMINATION PERIOD. WATER SEEDING AREAS TWICE DURING THE FIRST WEEK TO A MINIMUM DEPTH OF 6 INCHES WITH A FINE SPRAY. AND ONCE PER WEEK THEREAFTER AS NECESSARY TO SUPPLEMENT NATURAL RAIN TO EQUIVALENT OF 6 INCHES DEPTH.

G. AFTER APPLICATION, THE CONTRACTOR SHALL NOT OPERATE ANY EQUIPMENT OVER THE COVERED AREA.

H. PLACE EROSION BLANKET OVER AREAS SLOPED SLOPED 1:3 OR GREATER. ROLL EROSION BLANKET ON SLOPES WITHOUT STRETCHING OR PULLING. ANCHOR EROSION BLANKET WITH WIRE STAPLES AT THE EDGES AND THROUGH THE CENTER AT 36" INTERVALS. USE TRENCHEE IN EDGES PER MANUFACTURER'S RECOMMENDATION.

I. CONTRACTOR TO REAPPLY SEED AS NECESSARY IN ORDER TO GET ALL SEEDING AREAS ESTABLISHED AS INTENDED.

6. LAWN MAINTENANCE:

A. WITHIN THE CONTRACT LIMITS, THE CONTRACTOR SHALL PRODUCE A DENSE, WELL ESTABLISHED LAWN. THE CONTRACTOR SHALL BE RESPONSIBLE FOR THE REPAIR AND RE-SODDING OF ALL ERODED, SUNKEN OR BARE SPOTS UNTIL CERTIFICATION OF ACCEPTABILITY BY THE LANDSCAPE ARCHITECT OR OWNER. REPAIRED SODDING SHALL BE ACCOMPLISHED AS IN THE ORIGINAL WORK (INCLUDING REGRAIDING IF NECESSARY).

B. WATER EVERY DAY FOR TEN (10) SUCCESSIVE DAYS, THEN WATER THREE (3) TIMES PER WEEK (AT EVEN INTERVALS) FOR TWO (2) ADDITIONAL WEEKS. ALL WATERING SHALL BE OF SUFFICIENT QUANTITY TO WET OR RESTORE WATER TO DEPTH OF FOUR (4) INCHES. CONTRACTOR TO DETERMINE IF SITE IS IN A DROUGHT RESTRICTION AREA AND MUST FOLLOW CITY/ COUNTY PROTOCOL IF ANY ARE IN PLACE.

T. CLEAN-UP

UPON COMPLETION OF ALL PLANTING WORK AND BEFORE FINAL ACCEPTANCE, THE CONTRACTOR SHALL REMOVE ALL MATERIAL, EQUIPMENT, AND DEBRIS RESULTING FROM THEIR WORK. ALL PAVED AREAS SHALL BE BROOM CLEANED AND THE SITE LEFT IN A NEAT AND ACCEPTABLE CONDITION AS APPROVED BY THE OWNER'S AUTHORIZED REPRESENTATIVE.

U. PLANT MATERIAL MAINTENANCE

ALL PLANTS AND PLANTING INCLUDED UNDER THIS CONTRACT SHALL BE MAINTAINED BY WATERING, CULTIVATING, SPRAYING, AND ALL OTHER OPERATIONS NECESSARY TO INSURE A HEALTHY CONDITION BY THE CONTRACTOR UNTIL CERTIFICATION OF ACCEPTABILITY BY THE LANDSCAPE ARCHITECT OR OWNER. MAINTENANCE AFTER THE CERTIFICATION OF ACCEPTABILITY SHALL BE IN ACCORDANCE WITH THE SPECIFICATIONS IN THIS SECTION.

V. MAINTENANCE (ALTERNATE BID ITEM)

1. CONTRACTORS ARE REQUESTED TO PROVIDE A BID ESTIMATE FOR MAINTENANCE FOLLOWING THE INITIAL NINETY (90)-DAY MAINTENANCE PERIOD ON A COST PER MONTH BASIS.

W. GUARANTEE

1. THE LIFE AND SATISFACTORY CONDITION OF ALL PLANT MATERIAL INSTALLED BY THE LANDSCAPE CONTRACTOR SHALL BE GUARANTEED BY THE CONTRACTOR FOR A MINIMUM OF ONE (1) CALENDAR YEAR, COMMENCING AT THE TIME OF CERTIFICATION OF ACCEPTABILITY BY THE LANDSCAPE ARCHITECT OR OWNER.
2. THE LIFE AND SATISFACTORY CONDITION OF ALL OTHER PLANT MATERIAL (INCLUDING SOD) INSTALLED BY THE LANDSCAPE CONTRACTOR SHALL BE GUARANTEED BY THE CONTRACTOR FOR A MINIMUM OF NINETY (90) CALENDAR DAYS, COMMENCING AT THE TIME OF CERTIFICATION OF ACCEPTABILITY BY THE LANDSCAPE ARCHITECT OR OWNER.
3. REPLACEMENT: ANY PLANT NOT FOUND IN A HEALTHY GROWING CONDITION AT THE END OF THE GUARANTEE PERIOD SHALL BE REMOVED FROM THE SITE AND REPLACED AS SOON AS WEATHER CONDITIONS PERMIT. ALL REPLACEMENTS SHALL BE PLANTS OF THE SAME KIND AND SIZE AS SPECIFIED IN THE PLANT LIST. THEY SHALL BE FURNISHED, PLANTED, AND MULCHED AS SPECIFIED UNDER "PLANTING", AT NO ADDITIONAL COST TO THE OWNER.

4. IN THE EVENT THE OWNER DOES NOT ENGAGE THE CONTRACTOR FOR LANDSCAPE (AND IRRIGATION) MAINTENANCE, THE CONTRACTOR IS ENCOURAGED TO VISIT THE PROJECT SITE PERIODICALLY DURING THE ONE YEAR WARRANTY PERIOD TO EVALUATE MAINTENANCE PROCEDURES BEING PERFORMED BY THE OWNER. CONTRACTOR SHALL NOTIFY THE OWNER IN WRITING OF MAINTENANCE PROCEDURES OR CONDITIONS WHICH THREATEN VIGOROUS AND HEALTHY PLANT GROWTH. IT IS SUGGESTED SUCH SITE VISITS SHALL BE CONDUCTED A MINIMUM OF ONCE PER MONTH FOR A PERIOD OF TWELVE (12) MONTHS FROM THE DATE OF ACCEPTANCE.

X. FINAL INSPECTION AND ACCEPTANCE OF WORK

FINAL INSPECTION AT THE END OF THE GUARANTEE PERIOD SHALL BE ON PLANTING, CONSTRUCTION AND ALL OTHER INCIDENTAL WORK PERTAINING TO THIS CONTRACT. ANY REPLACEMENT AT THIS TIME SHALL BE SUBJECT TO THE SAME ONE (1) YEAR GUARANTEE (OR AS SPECIFIED BY THE LANDSCAPE ARCHITECT OR OWNER IN WRITING) BEGINNING WITH THE TIME OF REPLACEMENT AND ENDING WITH THE SAME INSPECTION AND ACCEPTANCE HEREIN DESCRIBED.



BGE, Inc.
2595 Dallas Parkway, Suite 101
Fris

GENERAL NOTES:

- VERIFY SITE INFORMATION, INCLUDING PROPERTY LINES, EASEMENTS, BUILDINGS, ROADWAY CURBS AND GUTTERS, UTILITIES AND OTHER INFORMATION AFFECTING THE SCOPE OF WORK INCLUDED ON THESE DRAWINGS. MORE SPECIFIC UTILITY INFORMATION IS INDICATED ON THE OTHER CONSULTANTS DRAWINGS, THE CIVIL DRAWINGS, AND SITE RECORD DRAWINGS AVAILABLE FROM THE OWNER. THE CONTRACTOR SHALL CONTACT THE OWNER AND THE LANDSCAPE ARCHITECT FOR DIRECTION ON HOW TO PROCEED IF ACTUAL SITE CONDITIONS VARY FROM WHAT IS SHOWN ON THE CIVIL ENGINEER'S OR LANDSCAPE ARCHITECT'S PLANS.
- THE CONTRACTOR SHALL NOTIFY LOCAL AUTHORITIES AND THE GENERAL CONTRACTOR FOR LOCATION OF EXISTING UNDERGROUND UTILITIES. EXCAVATE AS NECESSARY TO CONFIRM LOCATIONS PRIOR TO EXCAVATION.
- EXCAVATION IN THE VICINITY OF UTILITIES SHALL BE UNDERTAKEN WITH CARE. THE CONTRACTOR BEARS FULL RESPONSIBILITY FOR THIS WORK. THE CONTRACTOR SHALL VERIFY THE LOCATION OF ALL SITE UTILITIES PRIOR TO BEGINNING EXCAVATION. ANY DAMAGE TO UTILITIES THAT ARE TO REMAIN CAUSED BY ANY PERSON, VEHICLE, EQUIPMENT, OR TOOL RELATED TO THE EXECUTION OF THE CONTRACT SHALL BE REPAIRED IMMEDIATELY AT NO EXPENSE TO THE OWNER.
- CONTRACTOR TO VERIFY CONSTRUCTION COMPLIANCE WITH AMERICANS WITH DISABILITIES ACT (ADA) OF 1990, AS AMENDED, THE ADA ACCESSIBILITY GUIDELINES (ADAAG) OF 2004, AS AMENDED, AND THE TEXAS ACCESSIBILITY STANDARDS, AS AMENDED. NOTIFY LANDSCAPE ARCHITECT OF ANY DISCREPANCIES.
- CONTRACTOR TO PROVIDE NECESSARY EROSION CONTROL MEASURES AS NEEDED.
- ALL CONSTRUCTION WILL CONFORM TO THESE PLANS AND SPECIFICATIONS. ALL CONSTRUCTION WILL ALSO CONFORM TO ALL RELEVANT CITY STANDARDS AND SPECIFICATIONS.

DEMOLITION NOTES:

- CONTRACTOR TO VERIFY LOCATIONS OF EXISTING UTILITIES AND UNLESS NOTED OTHERWISE, MAINTAIN THEM IN OPERATION DURING CONSTRUCTION. CONTRACTOR IS RESPONSIBLE FOR ANY DAMAGE TO UTILITIES.
- REFERENCE CIVIL DRAWINGS FOR LIMITS OF REQUIRED DEMOLITION.
- CONTRACTOR SHALL TAKE CARE TO MINIMIZE DISTURBANCE TO EXISTING TREE TRUNKS AND ROOT SYSTEMS. ALL DEMOLITION ADJACENT TO EXISTING TREES SHALL BE COMPLETED USING HAND TOOLS, NO LARGE EQUIPMENT OR ANY EQUIPMENT WITH TRACKS SHALL BE ALLOWED TO WORK UNDER THE DRIP LINE OF ANY EXISTING TREES TO REMAIN. THERE SHALL BE NO STORAGE OF MATERIAL OR PARKING WITHIN THE DRIPLINE OF EXISTING TREES TO REMAIN.
- SITE BASE INFORMATION (BOUNDARIES, UTILITIES, TOPOGRAPHY & STRUCTURES) ARE SHOWN AS PROVIDED BY SURVEYOR. CONTRACTOR SHALL VERIFY GRADES, UTILITIES AND SITE CONDITIONS PRIOR TO BEGINNING CONSTRUCTION. BGE, INC ASSUMES NO LIABILITY FOR THE ACCURACY OF THIS SURVEY INFORMATION.
- DURING DEMOLITION THE CONTRACTOR SHALL EXERCISE CAUTION NOT TO DAMAGE THE EXISTING FEATURES THAT ARE TO REMAIN INSIDE AND OUTSIDE OF THE PROJECT CONSTRUCTION AREA. DAMAGE RESULTING FROM CONTRACTOR'S WORK SHALL BE REPAIRED AND RESTORED TO THE COMPLETE SATISFACTION OF THE OWNER AT THE EXPENSE OF THE CONTRACTOR. UTILITIES AND THEIR CONTINUATION THROUGH DEMOLISHED AREAS ARE TO REMAIN IN PLACE. PROTECT AS REQUIRED. DEMOLISH UTILITIES ONLY IF SHOWN ON THESE OR ARCHITECT/ENGINEERS DRAWINGS.
- CONTRACTOR IS RESPONSIBLE FOR FIELD VERIFICATION OF ALL AREAS TO BE DEMOLISHED AS A PART OF THIS CONTRACT. CONDITIONS VARYING FROM THESE PLANS & SPECIFICATIONS MUST BE BROUGHT TO THE IMMEDIATE ATTENTION OF THE LANDSCAPE ARCHITECT. CLEARLY MARK ALL ITEMS FOR DEMOLITION FOR LANDSCAPE ARCHITECTS APPROVAL PRIOR TO BEGINNING DEMOLITION WORK.
- CONTRACTOR WILL BE RESPONSIBLE FOR THE REMOVAL OF ALL DESIGNATED TREES, SHRUBS & GROUND COVER PRIOR TO THE START OF NEW CONSTRUCTION. CONTRACTOR WILL BE RESPONSIBLE FOR CAPPING & ABANDONING ALL IRRIGATION LINES IN THE DEMOLITION AREA.

PLANTING NOTES:

- CONTRACTOR SHALL STAKE OUT ALL INFORMAL TREE LOCATIONS IN FIELD USING COLORED FLAGS FOR EACH DIFFERENT TREE SPECIES FOR REVIEW AND APPROVAL BY THE LANDSCAPE ARCHITECT PRIOR TO EXCAVATION. THE LANDSCAPE ARCHITECT RESERVES THE RIGHT TO ADJUST PLANTS TO EXACT LOCATION IN FIELD.
- SHRUB, GROUND COVER & SEASONAL COLOR BED LAYOUTS SHALL BE STAKED FOR APPROVAL BY LANDSCAPE ARCHITECT PRIOR TO EXCAVATION.
- CONTRACTOR IS RESPONSIBLE FOR VERIFYING LOCATIONS OF UNDERGROUND UTILITIES PRIOR TO CONSTRUCTION.
- IT IS THE RESPONSIBILITY OF THE CONTRACTOR TO ADVISE THE LANDSCAPE ARCHITECT OF ANY CONDITION FOUND ON THE SITE WHICH PROHIBITS INSTALLATION AS SHOWN ON THESE DRAWINGS.
- ALL SHRUB & GROUND COVER BEDS SHALL HAVE A MINIMUM THREE (3) INCH LAYER OF HARDWOOD MULCH. CONTRACTOR TO SUPPLY OWNER WITH SAMPLE FOR APPROVAL. CONTRACTOR TO SUPPLY A BID ALTERNATE FOR ROCK MULCH FOR ALL BEDS.
- ANNUAL BEDS TO RECEIVE MINIMUM 3" HARDWOOD MULCH. CONTRACTOR TO SUPPLY OWNER WITH SAMPLE FOR APPROVAL.
- TREES SHALL BE PLANTED AS LEAST FOUR (4) FEET FROM ANY UTILITY LINE, CURB, SIDEWALK OR FIRE CONNECTION AND OUTSIDE ALL UTILITY EASEMENTS.
- TREES OVERHANGING SIDEWALKS AND PARKING OR PEDESTRIAN AREAS SHALL HAVE A MINIMUM CLEAR TRUNK BRANCHING HEIGHT OF SEVEN (7) FEET.
- TREES OVERHANGING VISIBILITY EASEMENTS OR RIGHT-OF WAYS SHALL HAVE A MINIMUM CLEAR TRUNK HEIGHT OF NINE (9) FEET.
- TREES OVERHANGING PUBLIC STREET PAVEMENT WILL HAVE A MINIMUM CLEAR TRUNK OF FOURTEEN (14) FEET.
- ALL PLANT MATERIAL SHALL BE MAINTAINED IN A HEALTHY AND GROWING CONDITION, AND MUST BE REPLACED WITH PLANT MATERIAL OF SIMILAR VARIETY AND SIZE IF DAMAGED, DESTROYED, OR REMOVED.
- LANDSCAPED AREAS SHALL BE KEPT FREE OF TRASH, LITTER, AND WEEDS AT ALL TIMES DURING CONSTRUCTION.
- LANDSCAPE CONTRACTOR SHALL BE RESPONSIBLE FOR FINE GRADING, REMOVAL OF MISCELLANEOUS DEBRIS AND ANY ADDITIONAL FILL REQUIRED TO CREATE A SMOOTH FINISHED GRADE PRIOR TO PLANTING IN ALL AREAS.
- FINAL GRADING SHALL BE APPROVED BY THE LANDSCAPE ARCHITECT IN THE FIELD PRIOR TO PLANTING.
- PLANT SPACING IS AS INDICATED ON 'PLANT SCHEDULE' UNLESS OTHERWISE NOTED. IT IS THE CONTRACTOR'S RESPONSIBILITY TO PROVIDE FULL COVERAGE IN ALL PLANTING AREAS AS SPECIFIED IN THE PLANT SCHEDULE REMARKS.
- CONTRACTOR SHALL PROVIDE THE PROJECT AGRONOMIST SOIL SAMPLES. A MINIMUM OF TWO SAMPLES FROM EACH DIFFERENT SOIL AREA AND FROM EACH IMPORT SOIL SOURCE IS REQUIRED. VERIFY APPROPRIATE QUANTITY OF SAMPLES WITH THE LANDSCAPE ARCHITECT AND AGRONOMIST. SAMPLES SHALL THEN BE TESTED AND ANALYZED FOR AGRICULTURAL SUITABILITY AND FERTILITY BY AN ACCREDITED SOIL TESTING LABORATORY. ANALYSIS SHALL INCLUDE REVIEW AND COORDINATION WITH SPECIFICATIONS AND RECOMMENDATIONS FOR SOIL PREPARATION AND BACK FILL MIX. SUBMIT SOILS ANALYSES TO LANDSCAPE ARCHITECT FOR APPROVAL PRIOR TO SOIL PREPARATION. THIS REQUIREMENT APPLIES TO ALL SOILS AND CONDITIONS WITHIN THIS PROJECT INCLUDING IMPORT SOILS, ON GRADE SOILS AND/OR ON-STRUCTURE SOILS. VERIFYING ON-STRUCTURE FILTER FABRIC/SOIL COMPATIBILITY SHALL BE PART OF THE OVERALL ANALYSIS. REFER TO SPECIFICATIONS FOR ADDITIONAL REQUIREMENTS.
- AN AUTOMATIC IRRIGATION SYSTEM SHALL BE PROVIDED TO IRRIGATE ALL LANDSCAPE AREAS. OVERSPRAY ON STREETS AND WALKS IS PROHIBITED.
- TOPSOIL SHALL BE A MINIMUM OF 4" IN DEPTH. SOIL SHALL BE FREE OF STONES, ROOTS AND ANY OTHER FOREIGN MATERIAL THAT IS NOT BENEFICIAL FOR PLANT GROWTH.
- REF. SHEET L3.12 FOR PLANTING DETAILS.
- REFER TO CIVIL FOR OVERALL SITE GRADING AND SHEET L3.5 FOR POOL AREA GRADING.

PLANT SCHEDULE

SYMBOL	CODE	QTY	BOTANICAL NAME	COMMON NAME	SIZE	COND	HT	SPR	REMARKS
CANOPY TREES									
	QM	6	Quercus macrocarpa	Burr Oak	4" cal	B&B	14' ht	6' spr	Full, Straight, Single Leader
	QS	11	Quercus shumardii	Shumard Red Oak	4" cal	B&B	12' ht	5' spr	Full, Straight, Single Trunk
	QV	4	Quercus virginiana	Southern Live Oak	4" cal	B&B	12' ht	6' spr	Full, Straight, Single Trunk
	TD	8	Taxodium distichum	Bald Cypress	4" cal	B&B	12' ht	5' spr	Full, Straight, Single Trunk
	UC	4	Ulmus crassifolia	Cedar Elm	4" cal	B&B	14' ht	5' spr	Full, Straight, Single Trunk
ORNAMENTAL TREES									
	CC	7	Cercis canadensis	Eastern Redbud	2" cal	CONT	8' ht	4' spr	Full, Multi-Trunk. Ornamental trees must be minimum 4' H at time of planting per city code.
	ID	6	Ilex decidua	Possumhaw Holly	2" cal	B&B	8' ht	4' spr	Full, Multi-Trunk. Ornamental trees must be minimum 4' H at time of planting per city code.
	IV	2	Ilex vomitoria	Yaupon Holly	2" cal	B&B	10' ht	4' spr	Full, Multi-Trunk. Ornamental trees must be minimum 4' H at time of planting per city code.
SHRUBS									
	HES PAR	12	Hesperaloe parviflora	Red Yucca	5 gal	CONT	24" ht	--	
	ILE CAR	8	Ilex cornuta 'Carissa'	Carissa Holly	5 gal	CONT	18" ht	--	Full, Matching,
	ILE NEL	31	Ilex x 'Nellie R. Stevens'	Nellie R. Stevens Holly	5 gal	CONT	30" ht	--	Full, Matching,
	LEU COM	133	Leucophyllum frutescens 'Compacta'	Compact Texas Sage	5 gal	CONT	24" ht	--	Full, Matching,
	SAL GRE	15	Salvia greggii	Autumn Sage	5 gal	CONT	18" ht	--	Full, Matching,
	YUC REC	20	Yucca recurvifolia	Soft Leaf Yucca	5 gal	CONT	24" ht	--	Full, Matching, 24" o.c. spacing
GRASSES									
	MUH CAP	199	Muhlenbergia capillaris	Pink Muhly	3 gal	CONT	24" ht	--	Full, Matching, 30" o.c. spacing
	NAS	143	Nassella tenuissima	Mexican Feather Grass	3 gal	CONT	18" ht	--	Full, Matching, 24" o.c. spacing
GROUND COVER									
	EFC	845	Euonymus fortunei 'Coloratus'	Purple-leaf Winter Creeper	1 gal	CONT	6" ht	6" spr	Full, 1 gallon min., 18" o.c. spacing
SEED									
	DSM	2,700 sf		Dam Slope Mix	---	---	---	---	Drill seed, Native American Seed Mix #2808, Ref. Planting Specs
	DFM	6,500 sf		Drainfield Mix	---	---	---	---	Drill seed, Native American Seed Mix #2861, Ref. Planting Specs
SOD									
	SOD	18,490 sf	Cynodon dactylon	Tif Tuf Bermuda Grass	---	---	---	---	Solid Sod, light sand filled joints, 100% weed, disease and pest free
MISC									
	STEEL EDGE	TBD	Steel Edging		---	---	---	---	3/8" x 6", black
	MULCH	TBD	Shredded Hardwood Mulch		---	---	---	---	Min. 3" depth, trees in sod to receive 4" dia. ring

IRRIGATION NOTES:

- LINE LAYOUT IS DIAGRAMMATIC-ADJUST HEAD AND LINE LOCATIONS ON SITE TO ACCOMMODATE EXISTING JOB CONDITIONS AND TO ACHIEVE COMPLETE COVERAGE.
- ALL MAIN LINE PIPING SHALL BE BURIED TO HAVE A MINIMUM COVER OF 18". ALL LATERAL PIPING DOWNSTREAM OF THE MAIN LINE SHALL BE BURIED TO HAVE A MINIMUM COVER OF 12".
- ALL MAINS ARE TO DRAIN TO LOW POINTS AT A MINIMUM ONE HALF (1/2%) PERCENT SLOPE. AT LOW POINTS, INSTALL GATE VALVE TO FACILITATE DRAINAGE OF SYSTEM DURING FREEZING TEMPERATURES.
- CONTRACTOR SHALL INSTALL AUTOMATIC DRAIN VALVES AT LOW POINTS IN THE IRRIGATION LINES AS REQUIRED TO PREVENT FREEZE DAMAGE.
- ALL VALVE BOXES SHALL BE BLACK IN COLOR (BODY AND LID). SIZES SHALL BE TEN (10") INCHES BY FOURTEEN (14") INCHES (RECTANGULAR) FOR REMOTE CONTROL VALVES AND NINE (9") INCHES (ROUND) FOR GATE AND QUICK COUPLER VALVES.
- CONTRACTOR SHALL MAKE MINOR ADJUSTMENTS TO SYSTEM LAYOUT IN FIELD TO INSURE POSITIVE DRAINAGE OF LATERAL LINES AND MAIN LINES.
- ALL WIRING FROM THE IRRIGATION CONTROLLER TO THE REMOTE CONTROL VALVES SHALL BE UF-14/1 DIRECT BURIAL CABLE. ALL WIRE SPLICES SHALL BE MADE IN VALVE BOXES ONLY USING RAINBIRD SNAP-TITE CONNECTORS AND SEALANT. PROVIDE SLEEVES FOR WIRE UNDER PAVED AREAS AS REQUIRED.
- ALL IRRIGATION INSTALLATION SHALL CONFORM TO THE LOCAL CODE REGULATIONS AND TCEQ REQUIREMENTS.
- IRRIGATION SYSTEM SHALL BE INSTALLED AND FULLY OPERATIONAL BEFORE INSTALLATION OF LANDSCAPE PLANTINGS.
- IRRIGATION HEADS SHALL BE PLACED AND ADJUSTED SO AS NOT TO SPRAY ON THE BUILDING.
- IRRIGATION HEADS SHALL BE PLACED AND SIZED SO AS NOT TO BE SUSCEPTIBLE TO DAMAGE BY AUTOMOBILE OVERHANGS.
- IRRIGATION CONTRACTOR SHALL PLACE ADJUSTABLE ARC NOZZLES IN PLACE OF FIXED ARC NOZZLE AS NEEDED TO ELIMINATE OVER SPRAY ON TO PAVEMENT.
- ALL IRRIGATION HEADS SHALL HAVE FACTORY INSTALLED CHECK VALVES.

NOTE: PLANT QUANTITIES ARE PROVIDED FOR CONVENIENCE ONLY. IN THE CASE OF A DISCREPANCY, THE DRAWING SHALL TAKE PRECEDENCE.

MAINTENANCE NOTES:

- LANDSCAPE CONTRACT SHALL INCLUDE, AS AN ALTERNATE BID, A LANDSCAPE MAINTENANCE AGREEMENT. THE LANDSCAPE MAINTENANCE PERIOD SHALL BEGIN ONCE OWNER'S ACCEPTANCE OF IMPROVEMENTS HAS BEEN GIVEN IN WRITING AND EXTEND FOR A PERIOD OF TWO YEARS.
- MAINTENANCE AGREEMENT SHALL GENERALLY CONFORM TO LANDSCAPE MAINTENANCE GUIDELINES PROVIDED BY OWNER AND MODIFIED TO MEET THE BEST MANAGEMENT PRACTICES OF THE LOCAL CLIMATE AND SITE SPECIFIC CONDITIONS.
- AT A MINIMUM, THE AGREEMENT SHALL INCLUDE, ALL LABOR AND MATERIALS TO PERFORM THE PROFESSIONAL MAINTENANCE OF THE SITE'S LANDSCAPE IMPROVEMENTS. THE AGREEMENT SHALL BE WRITTEN TO INCLUDE, BUT MAY NOT BE LIMITED TO, THE FOLLOWING:
A. LAWN CARE
B. FERTILIZATION
C. INTEGRATED PEST MANAGEMENT
D. IRRIGATION
E. PLANTING BEDS
F. TREES AND SHRUBS
- THE PROGRAM FOR THE MAINTENANCE AGREEMENT SHALL BE BASED ON A COMPLETE SOILS ANALYSIS TO ADDRESS SPECIFIC SITE CONDITIONS AND TO ENSURE THE HEALTHY AND VIGOROUS GROWTH OF THE PLANT MATERIALS.

TOTAL SITE AREA
119,354 SF (2.73 AC)

CITY OF ROCKWALL - CODE REQUIREMENTS

LANDSCAPE AREA	REQUIRED	PROVIDED
20% OF SITE 119,354 SF X 20% = 23,871 SF IMPERVIOUS AREA= 84,111 SF	23,871 SF 20%	34,243 SF 29%
SITE TREES 12 TREES PER ACRE 2.74 AC X 12 = 32.88 TREES	33 TREES	33 TREES
DETENTION BASIN DETENTION BASIN = 6500 SF 1 CANOPY TREE PER 750 SF = 9 TREES 1 ACCENT TREE PER 1500 SF = 5	9 TREES 5 TREES	9 TREES 5 TREES
F.M. 3097 LANDSCAPE BUFFER: 20' DEPTH MIN. 30" HT SHRUBS CANOPY TREES 2 TREES PER 100 LF (234.5 LF / 100) x 2 = 5 TREES ACCENT TREES 4 TREE PER 100 LF (234.5 LF / 100) x 4 = 10 TREES	REQUIRED YES YES 5 TREES 10 TREES	PROVIDED YES YES 5 TREES 10 TREES
SCREENING FROM RESIDENTIAL SCREENING TREES SCREENING SHRUBS 20' BUFFER	REQUIRED 11 TREES YES YES	PROVIDED 10 PROPOSED, 1 EXISTING YES YES
HEADLIGHT SCREENING MIN. 2' HT BERM EVERGREEN SHRUBS	REQUIRED YES YES	PROVIDED YES YES
PARKING REQUIREMENTS MIN. 5% INTERIOR LANDSCAPING TOTAL PARKING= 21,529 SF PARKING TREES 1 TREE PER 10 SPACES 116 SPACES / 10 = 12 TREES 1 TREE WITHIN 80 LF OF EACH SPACE	REQUIRED 1,073 SF 12 TREES YES	PROVIDED 1,834 SF 12 TREES YES
TREE MITIGATION TREE MITIGATION	REQUIRED 15"	PROVIDED YES, PROVIDED BY REQUIRED TREES

IRRIGATION NOTE:
ALL PLANT MATERIAL TO BE IRRIGATED IN COMPLIANCE TO CITY OF ROCKWALL, UNIFIED DEVELOPMENT CODE ARTICLE 8.05.04



BGE, Inc.
2595 Dallas Parkway, Suite 101
Frisco, TX 75034
Tel: 972-464-4800 • www.bgeinc.com
TBPE Registration No. F-1046
Copyright 2024

DEVELOPER
PLATINUM CONSTRUCTION
1450 TL TOWNSEND DR. STE 100
ROCKWALL, TX 75032
TEL: (469) 222-1597
CONTACT: SHAWN VALK

OWNER
SARO PARTNERS LLC
1450 S. T L TOWNSEND
ROCKWALL, TX 75032
TEL: (000) 000-0000
CONTACT: JAY KANTER

CITY SUBMITTAL SET
PLANTING SCHEDULE AND NOTES
HORIZON RD. COMMERCIAL OFFICES
W.W FORD SURVEY, ABSTRACT NO. 80, TRACT 26-4
CITY OF ROCKWALL, ROCKWALL COUNTY, TEXAS

THESE PLANS ARE ISSUED FOR THE PURPOSE OF PRELIMINARY REVIEW AND ARE NOT INTENDED FOR CONSTRUCTION. WHEN ISSUED IN FINAL FORM THEY WILL BE SEALED, SIGNED AND DATED.

RESPONSIBLE LANDSCAPE ARCHITECT:
MICHAEL STOTLER, PLA
TEXAS REGISTRATION NO. 3743
BGE, INC.
REGISTERED ENGINEERING FIRM F-1046
10/8/2024

!CAUTION!
Contractor to Verify exact location & Depth of Exist Facilities Prior to any Construction Activities

!CAUTION!
CONTACT: 1-800-DIG-TESS
48 HOURS PRIOR TO CONSTRUCTION

REVISIONS		
REV. NO.	DATE	DESCRIPTION

CHECKED BY: MLS
DESIGNED BY: NPS
DATE: 10/8/2024
PROJECT NUMBER: 13185-00

SITE PLAN
CASE NUMBER: SP2024-040
HORIZON ROAD COMMERCIAL OFFICES
2.7391 ACRES (119316 SF.) BEING SITUATED IN THE W.W FORD SURVEY, ABSTRACT NO. 80
CITY OF ROCKWALL, ROCKWALL COUNTY, TEXAS
SUBMITTED: SEPTEMBER 13, 2024
RESUBMITTED: OCTOBER 1, 2024

SHEET NO
L2.01
PLANTING SCHEDULE AND NOTES

BGE, INC. PROJECT: PLATINUM CONSTRUCTION\118-00-01a_Rev_01.dwg, Date: 10/8/2024, 11:58am, author: BGE, INC. THE DOCUMENT, TOGETHER WITH THE CONCEPTS AND DESIGNS PRESENTED HEREIN, IS AN INSTRUMENT OF SERVICE. IT IS INTENDED ONLY FOR THE SPECIFIC PURPOSE AND CLIENT FOR WHICH IT WAS PREPARED. REUSE OF AND IMPROPER RELIANCE ON THIS DOCUMENT WITHOUT WRITTEN AUTHORIZATION AND ADAPTATION BY BGE, INC. SHALL BE WITHOUT LIABILITY TO BGE, INC.

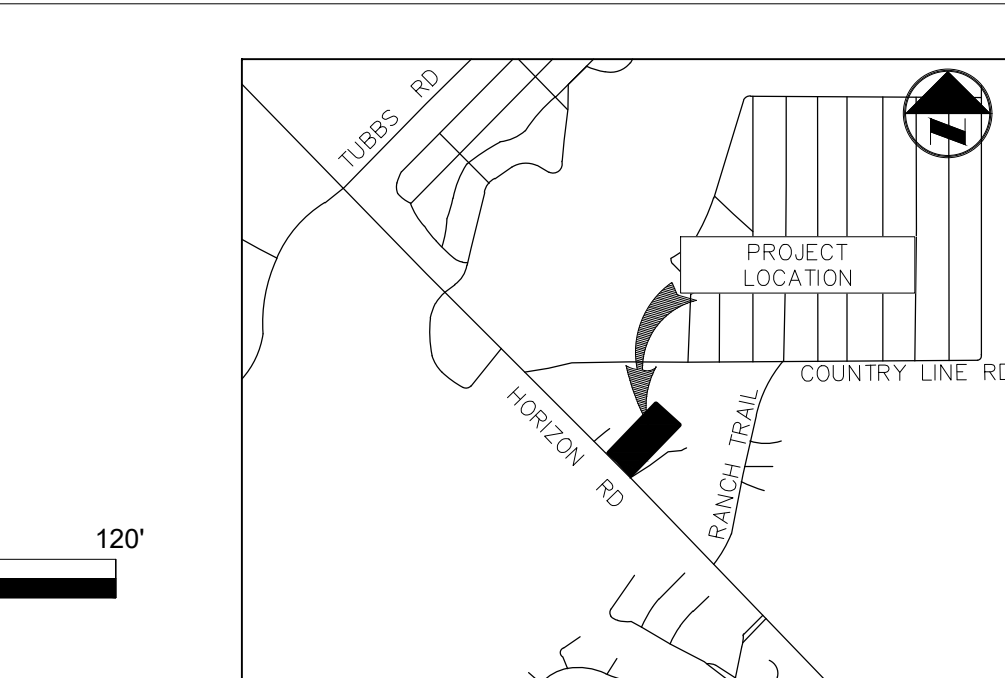
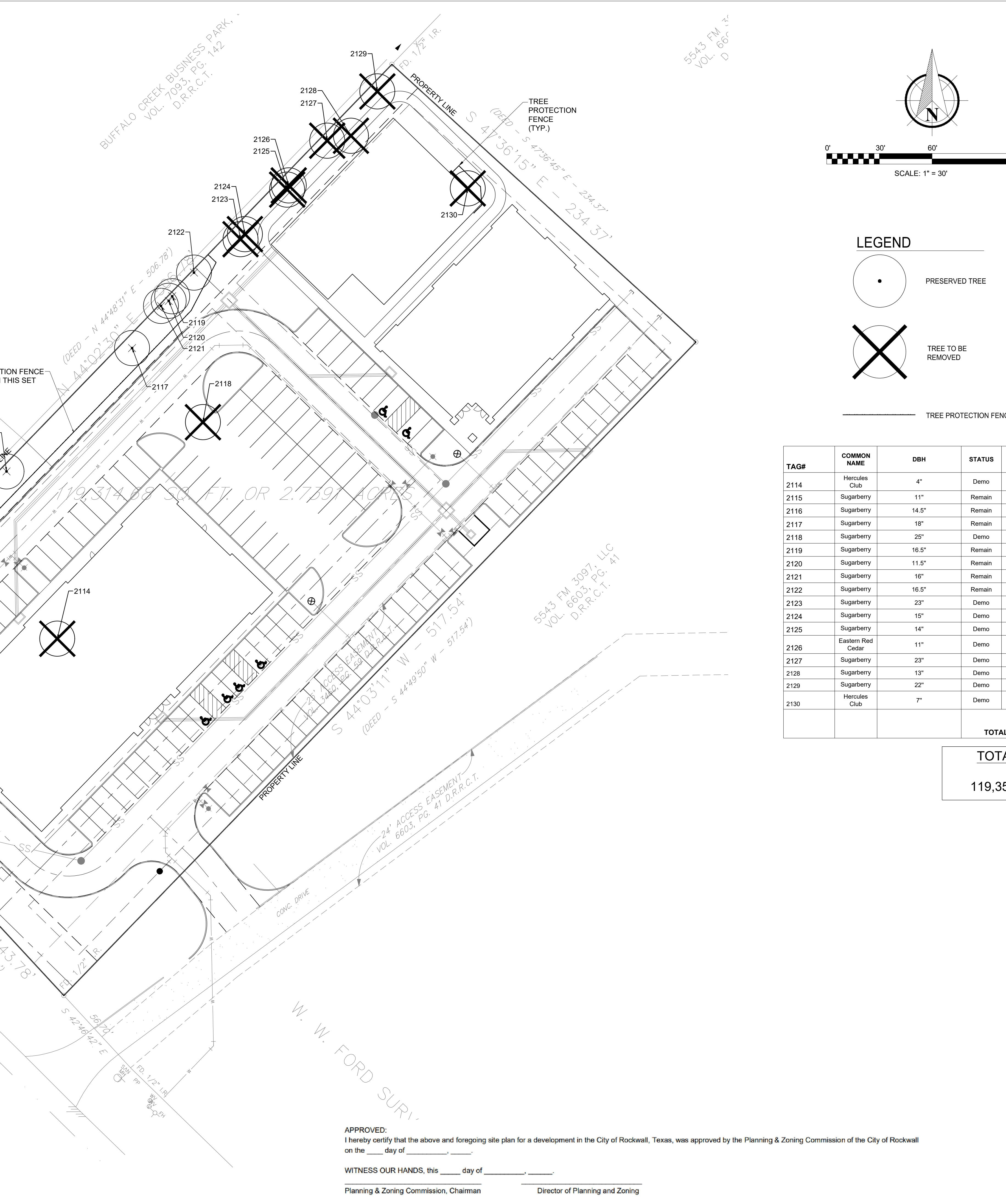

VICINITY MAP
(NOT TO SCALE)

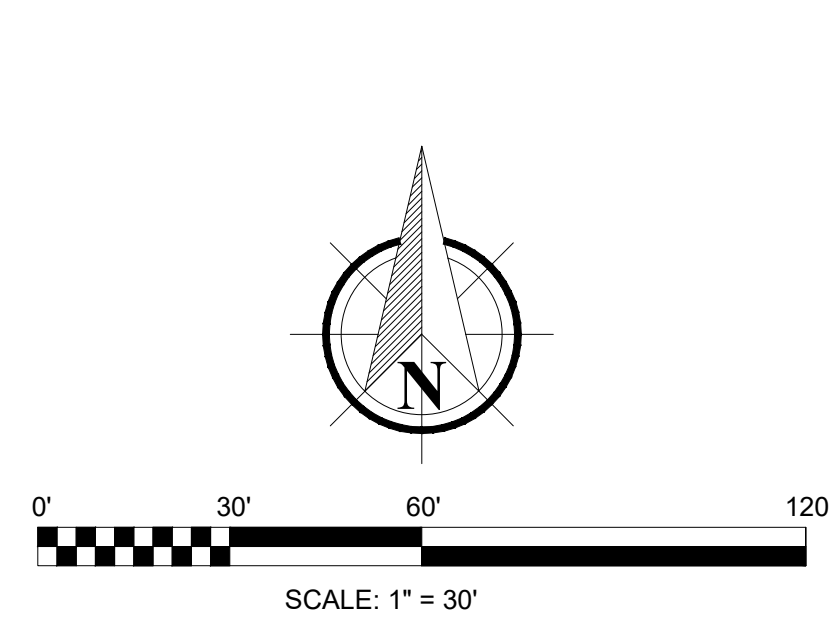

LEGEND

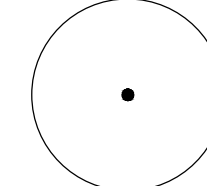
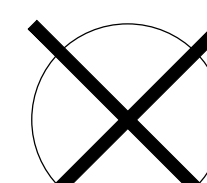
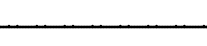
-  PRESERVED TREE
-  TREE TO BE REMOVED
-  TREE PROTECTION FENCE

TAG#	COMMON NAME	DBH	STATUS	TREE HEALTH	DISEASE	INSECT	STRUCTURAL	MITIGATION INCHES
2114	Hercules Club	4"	Demo	4	N	N	N	4
2115	Sugarberry	11"	Remain	2	Y	N	N	0
2116	Sugarberry	14.5"	Remain	4	N	N	N	0
2117	Sugarberry	18"	Remain	4	N	N	N	0
2118	Sugarberry	25"	Demo	4	N	N	N	0
2119	Sugarberry	16.5"	Remain	4	N	N	N	0
2120	Sugarberry	11.5"	Remain	4	N	N	N	0
2121	Sugarberry	16"	Remain	4	N	N	N	0
2122	Sugarberry	16.5"	Remain	4	N	N	N	0
2123	Sugarberry	23"	Demo	4	N	N	N	0
2124	Sugarberry	15"	Demo	4	N	N	N	0
2125	Sugarberry	14"	Demo	4	N	N	N	0
2126	Eastern Red Cedar	11"	Demo	4	N	N	N	4
2127	Sugarberry	23"	Demo	4	N	N	N	0
2128	Sugarberry	13"	Demo	4	N	N	N	0
2129	Sugarberry	22"	Demo	4	N	N	N	0
2130	Hercules Club	7"	Demo	4	N	N	N	7
TOTAL MITIGATION INCHES								15

TOTAL SITE AREA
119,354 SF (2.73 AC)

CITY SUBMITTAL SET
TREE PRESERVATION PLAN
HORIZON RD. COMMERCIAL OFFICES
W.W FORD SURVEY, ABSTRACT NO. 80, TRACT 26-4
CITY OF ROCKWALL, ROCKWALL COUNTY, TEXAS

THESE PLANS ARE ISSUED FOR THE PURPOSE OF PRELIMINARY REVIEW AND ARE NOT INTENDED FOR CONSTRUCTION. WHEN ISSUED IN FINAL FORM THEY WILL BE SEALED, SIGNED AND DATED.
 RESPONSIBLE LANDSCAPE ARCHITECT:
 MICHAEL STOTTLER, P.L.A.
 TEXAS REGISTRATION NO. 3743
 BGE, INC.
 TEXAS REGISTERED ENGINEERING FIRM F-1046
 10/8/2024

!CAUTION!
 Contractor to Verify exact location & Depth of Exist Facilities Prior to any Construction Activities

CAUTION!!!
 CONTACT: 1-800-DIG-TESS
 48 HOURS PRIOR TO CONSTRUCTION

REVISIONS		
REV. NO.	DATE	DESCRIPTION

CHECKED BY: MLS
 DESIGNED BY: NPS
 DATE: 10/8/2024
 PROJECT NUMBER: 13185-00

SHEET NO
L1.00
TREE PRESERVATION PLAN

APPROVED:
 I hereby certify that the above and foregoing site plan for a development in the City of Rockwall, Texas, was approved by the Planning & Zoning Commission of the City of Rockwall on the ____ day of _____.
 WITNESS OUR HANDS, this ____ day of _____.
 Planning & Zoning Commission, Chairman Director of Planning and Zoning

SITE PLAN
CASE NUMBER: SP2024-040
HORIZON ROAD COMMERCIAL OFFICES
2.7391 ACRES (119316 SF) BEING SITUATED IN
THE W.W FORD SURVEY, ABSTRACT NO. 80
CITY OF ROCKWALL, ROCKWALL COUNTY, TEXAS
 SUBMITTED: SEPTEMBER 13, 2024
 RESUBMITTED: OCTOBER 1, 2024

BGE
BGE, Inc.
 2595 Dallas Parkway, Suite 101
 Frisco, TX 75034
 Tel: 972-464-4800 • www.bgeinc.com
 TBPE Registration No. F-1046
 Copyright 2024

DEVELOPER
PLATINUM CONSTRUCTION
 1450 TL TOWNSEND DR. STE 100
 ROCKWALL, TX 75032
 TEL: (469) 222-1597
 CONTACT: SHAWN VALK

OWNER
SARO PARTNERS LLC
 1450 S. T L TOWNSEND
 ROCKWALL, TX 75302
 TEL: (000) 000-0000
 CONTACT: JAY KANTER



BGE, Inc.
 2595 Dallas Parkway, Suite 101
 Frisco, TX 75034
 Tel: 972-464-4800 • www.bgeinc.com
 TBPE Registration No. F-1046
 Copyright 2024

DEVELOPER
PLATINUM CONSTRUCTION
 1450 TL TOWNSEND DR. STE 100
 ROCKWALL, TX 75032
 TEL: (469) 222-1597
 CONTACT: SHAWN VALK

OWNER
SARO PARTNERS LLC
 1450 S. T. L. TOWNSEND
 ROCKWALL, TX 75302
 TEL: (000) 000-0000
 CONTACT: JAY KANTER

CITY SUBMITTAL SET

TREE PRESERVATION DETAILS

HORIZON RD. COMMERCIAL OFFICES
 W.W FORD SURVEY, ABSTRACT NO. 80, TRACT 26-4
 CITY OF ROCKWALL, ROCKWALL COUNTY, TEXAS

THESE PLANS ARE ISSUED FOR THE PURPOSE OF PRELIMINARY REVIEW AND ARE NOT INTENDED FOR CONSTRUCTION. WHEN ISSUED IN FINAL FORM THEY WILL BE SEALED, SIGNED AND DATED.

RESPONSIBLE LANDSCAPE ARCHITECT:
 MICHAEL STOTTLER, P.L.A.
 TEXAS REGISTRATION NO. 3743
 BGE, INC.
 REGISTERED ENGINEERING FIRM F-1046
 10/8/2024

CAUTION !!
 Contractor to Verify exact location & Depth of Exist Facilities Prior to any Construction Activities

CAUTION !!!
 CONTACT: 1-800-DIG-TESS
 48 HOURS PRIOR TO CONSTRUCTION

REVISIONS		
REV. NO.	DATE	DESCRIPTION

CHECKED BY: MLS
 DESIGNED BY: NPS
 DATE: 10/8/2024
 PROJECT NUMBER: 13185-00

SHEET NO
L1.01

TREE PRESERVATION DETAILS

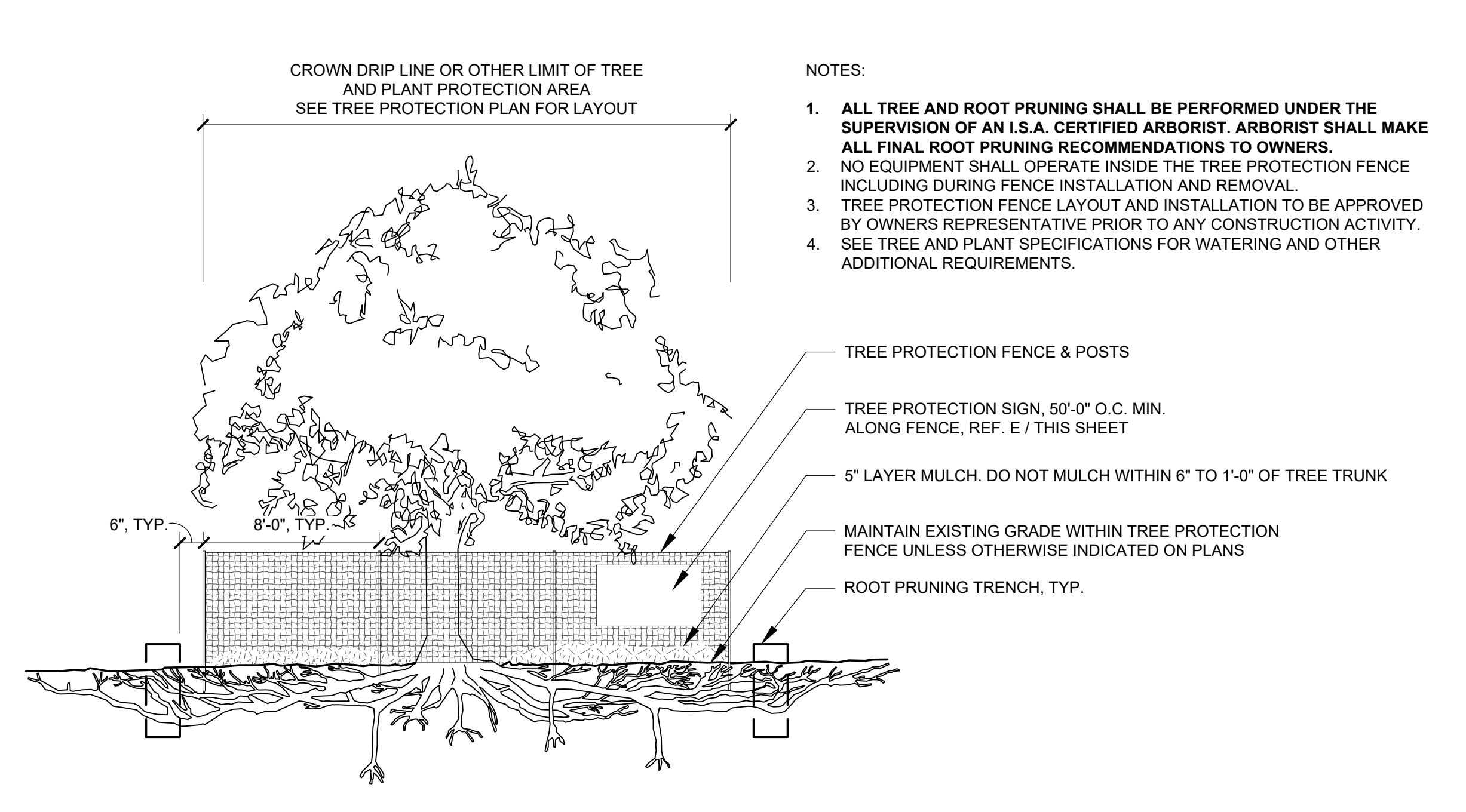

- NOTES:
1. ALL TREE AND ROOT PRUNING SHALL BE PERFORMED UNDER THE SUPERVISION OF AN I.S.A. CERTIFIED ARBORIST. ARBORIST SHALL MAKE ALL FINAL ROOT PRUNING RECOMMENDATIONS TO OWNERS.
 2. NO EQUIPMENT SHALL OPERATE INSIDE THE TREE PROTECTION FENCE INCLUDING DURING FENCE INSTALLATION AND REMOVAL.
 3. TREE PROTECTION FENCE LAYOUT AND INSTALLATION TO BE APPROVED BY OWNERS REPRESENTATIVE PRIOR TO ANY CONSTRUCTION ACTIVITY.
 4. SEE TREE AND PLANT SPECIFICATIONS FOR WATERING AND OTHER ADDITIONAL REQUIREMENTS.

A TYPICAL TREE PROTECTION FENCING
 SECTION NOT TO SCALE

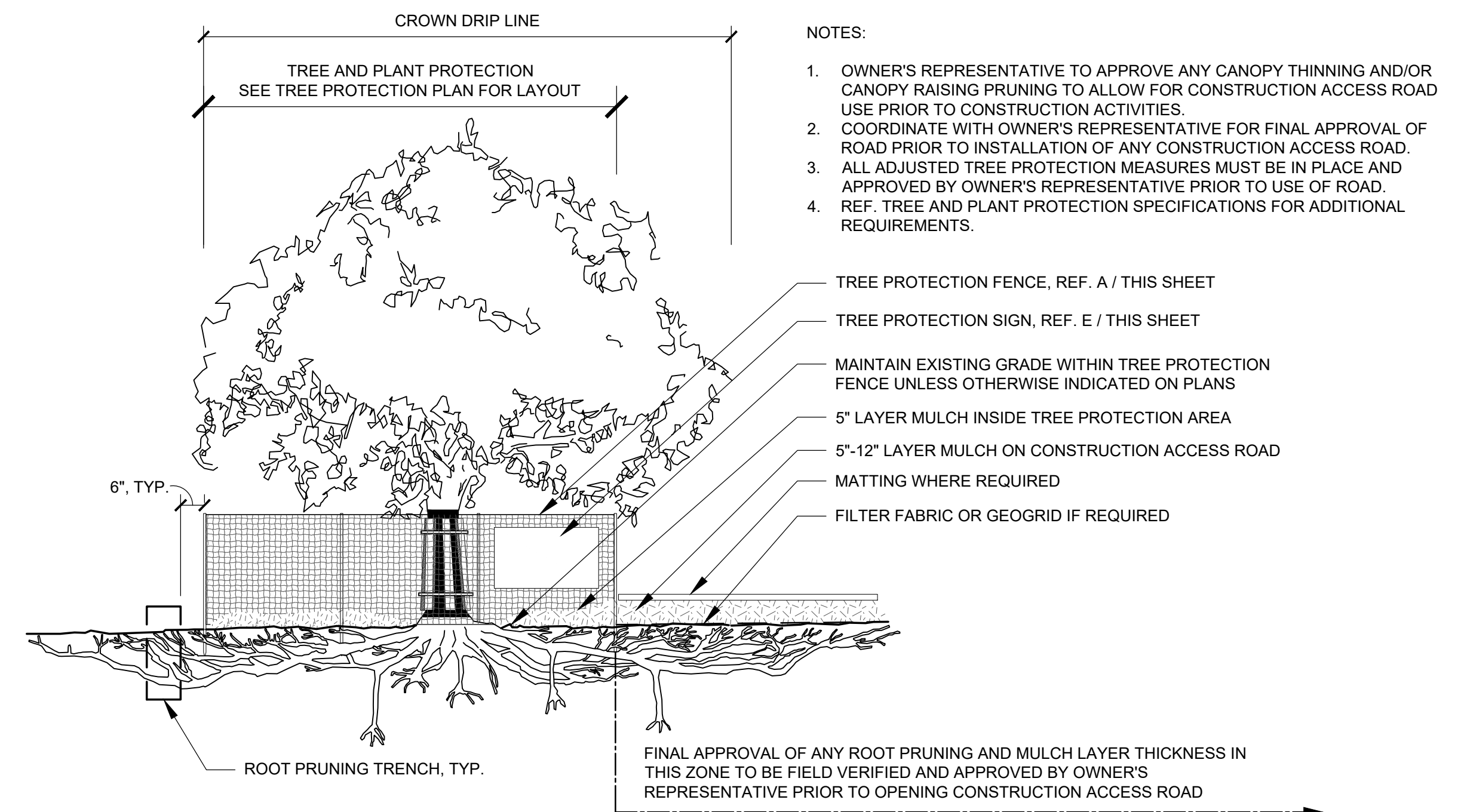

- NOTES:
1. OWNER'S REPRESENTATIVE TO APPROVE ANY CANOPY THINNING AND/OR CANOPY RAISING PRUNING TO ALLOW FOR CONSTRUCTION ACCESS ROAD USE PRIOR TO CONSTRUCTION ACTIVITIES.
 2. COORDINATE WITH OWNER'S REPRESENTATIVE FOR FINAL APPROVAL OF ROAD PRIOR TO INSTALLATION OF ANY CONSTRUCTION ACCESS ROAD.
 3. ALL ADJUSTED TREE PROTECTION MEASURES MUST BE IN PLACE AND APPROVED BY OWNER'S REPRESENTATIVE PRIOR TO USE OF ROAD.
 4. REF. TREE AND PLANT PROTECTION SPECIFICATIONS FOR ADDITIONAL REQUIREMENTS.

C TREE PROTECTION: CONSTRUCTION ACCESS ROAD
 SECTION NOT TO SCALE

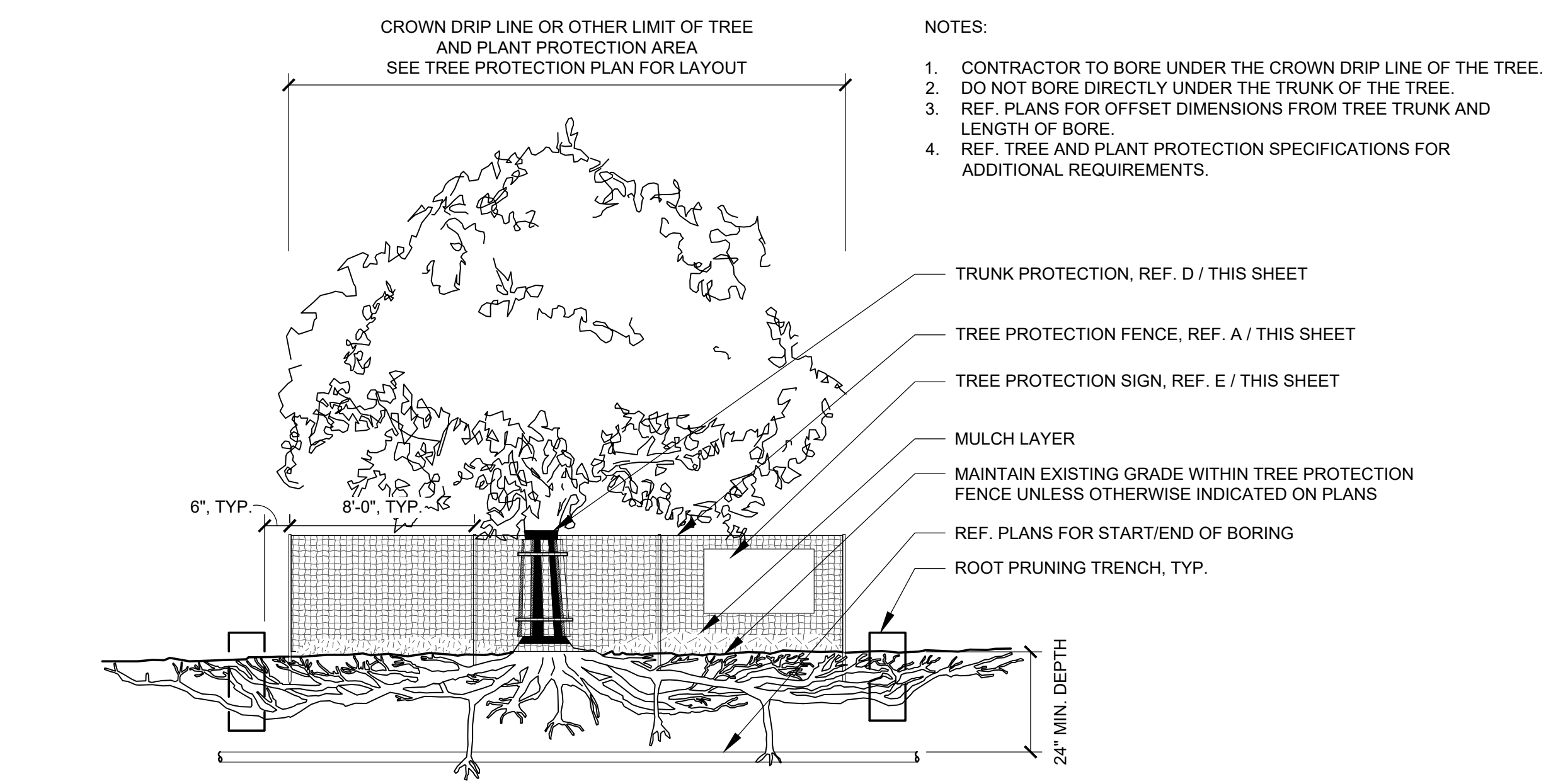

- NOTES:
1. CONTRACTOR TO BORE UNDER THE CROWN DRIP LINE OF THE TREE. DO NOT BORE DIRECTLY UNDER THE TRUNK OF THE TREE.
 2. DO NOT BORE DIRECTLY UNDER THE TRUNK OF THE TREE.
 3. REF. PLANS FOR OFFSET DIMENSIONS FROM TREE TRUNK AND LENGTH OF BORE.
 4. REF. TREE AND PLANT PROTECTION SPECIFICATIONS FOR ADDITIONAL REQUIREMENTS.

B TREE PROTECTION: UTILITY BORING UNDER DROWN DRIP LINE
 SECTION NOT TO SCALE

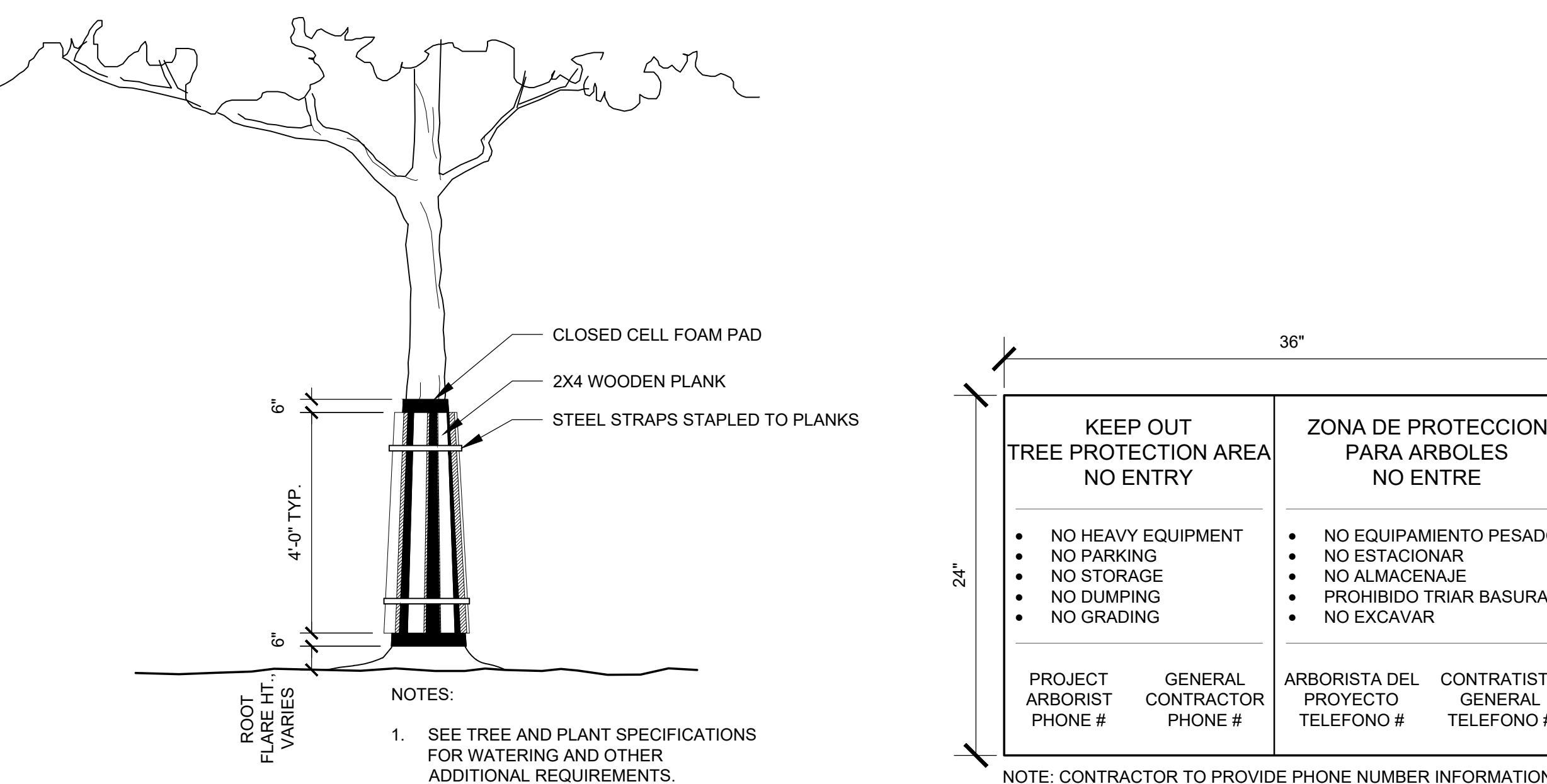

- NOTES:
1. SEE TREE AND PLANT SPECIFICATIONS FOR WATERING AND OTHER ADDITIONAL REQUIREMENTS.

D TRUNK PROTECTION
 ELEVATION NOT TO SCALE

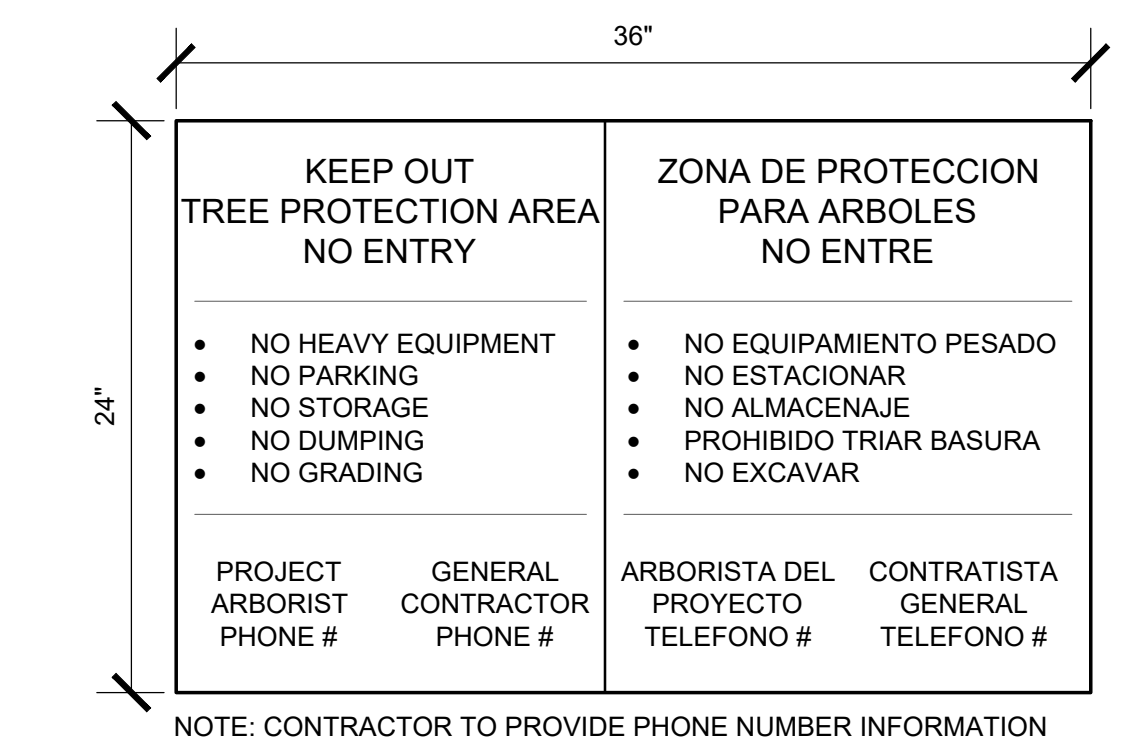

NOTE: CONTRACTOR TO PROVIDE PHONE NUMBER INFORMATION

E TRUNK PROTECTION
 ENLARGEMENT NOT TO SCALE

APPROVED:
 I hereby certify that the above and foregoing site plan for a development in the City of Rockwall, Texas, was approved by the Planning & Zoning Commission of the City of Rockwall on the ___ day of _____.
 WITNESS OUR HANDS, this ___ day of _____.
 Planning & Zoning Commission, Chairman Director of Planning and Zoning

SITE PLAN
 CASE NUMBER: SP2024-040
 HORIZON ROAD COMMERCIAL OFFICES
 2.7391 ACRES (119316 SF.) BEING SITUATED IN
 THE W.W FORD SURVEY, ABSTRACT NO. 80
 CITY OF ROCKWALL, ROCKWALL COUNTY, TEXAS
 SUBMITTED: SEPTEMBER 13, 2024
 RESUBMITTED: OCTOBER 1, 2024

BGE, INC. THIS DOCUMENT, TOGETHER WITH THE CONCEPTS AND DESIGNS PRESENTED HEREIN, IS AN INSTRUMENT OF SERVICE. IT IS INTENDED ONLY FOR THE SPECIFIC PURPOSE AND CLIENT FOR WHICH IT WAS PREPARED. REUSE OF AND IMPROPER RELIANCE ON THIS DOCUMENT WITHOUT WRITTEN AUTHORIZATION AND ADAPTATION BY BGE, INC. SHALL BE WITHOUT LIABILITY TO BGE, INC.

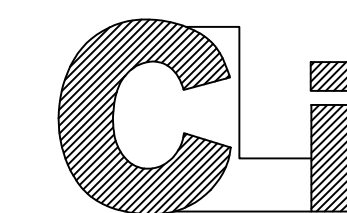

CLI Design
Los Angeles, Miami & New York
Tel: 800-755-0155 | Fax: 760-262-3940

No.	Issue	Date
0.		08.16.2024
1.		10.03.2024

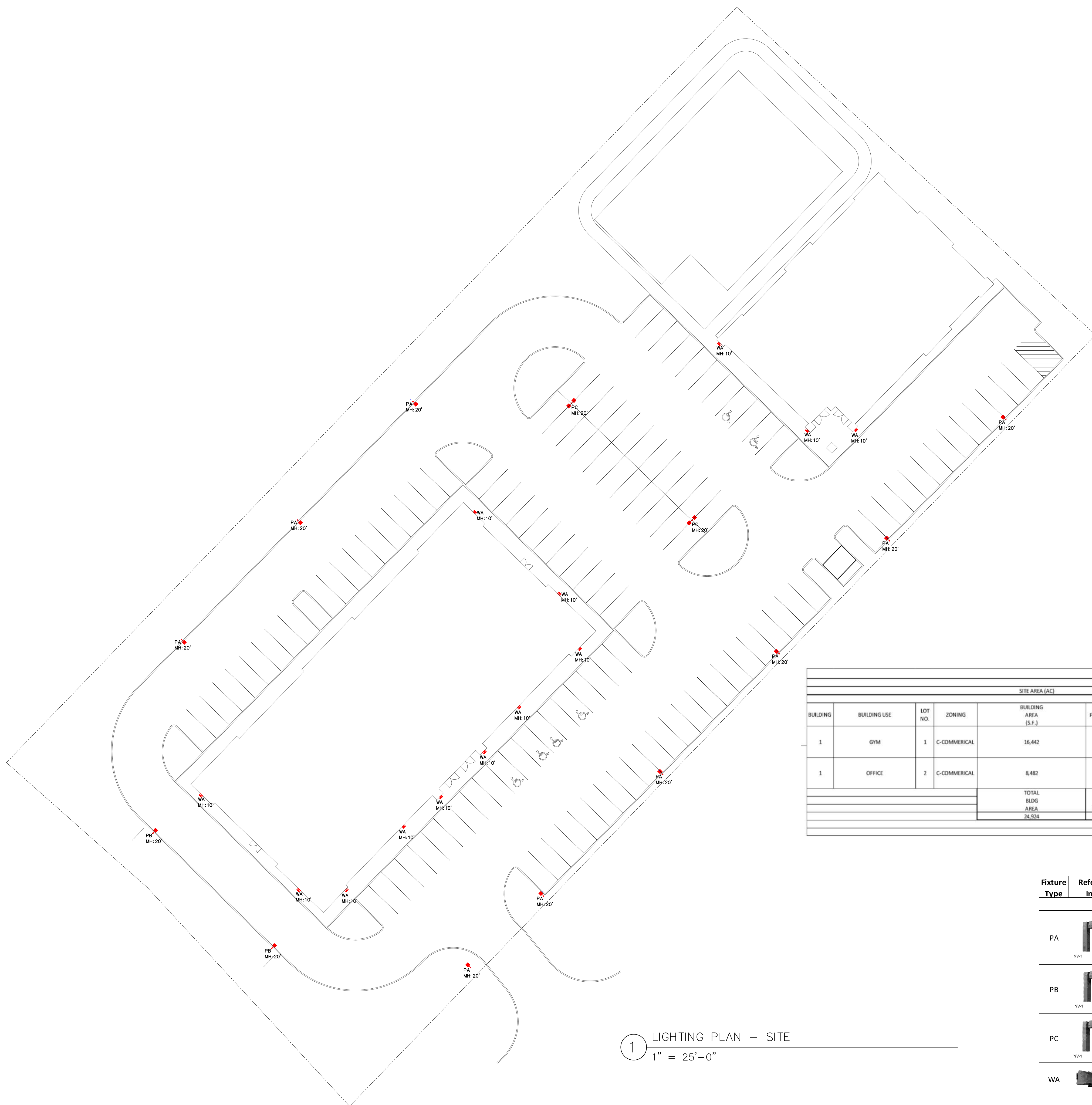

SITE INFORMATION																	
SITE AREA																	
SITE AREA (AC)										2.74 AC (119,354 SF)							
SITE DATA SUMMARY																	
BUILDING	BUILDING USE	LOT NO.	ZONING	BUILDING AREA (S.F.)	BLDG FOOTPRINT (S.F.)	FLOOR AREA RATIO	LOT AREA (S.F.)	LOT COV. (%)	IMPERVIOUS LOT COVERAGE (S.F.)	PROPOSED BUILDING HEIGHT	# OF BUILDING STORIES	PARKING RATIO	PARKING REQUIRED	TOTAL PARKING REQUIRED	TOTAL PARKING PROVIDED	HANDICAP PARKING REQUIRED	HANDICAP PARKING PROVIDED
1	GYM	1	C-COMMERCIAL	16,442	16,442	0.274	59,497	27.37	46,430	42'	1+ Mezzanine	1/200 (GYM)	83	83	83	4	4
1	OFFICE	2	C-COMMERCIAL	8,482	8,482	0.14	59,025	14.37	37,681	24'	1	1/300 (OFFICE)	29	29	33	2	2
				TOTAL BLDG AREA	TOTAL BLDG FOOTPRINT	TOTAL FLOOR AREA RATIO											
				24,924	24,924	0.417											

NOTE: HANDICAP PARKING IS PROVIDED IN ACCORDANCE WITH ADA STANDARDS

1 LIGHTING PLAN – SITE
1" = 25'-0"

Fixture Type	Reference Image	Description	Dimming Interface	Product Registration ID	Lamps, CCT, Lumen, Optics, CRI	Input Voltage	Fixture Wattage	Mounting, Finishes, Remarks & Other Notes
EXTERIOR FIXTURE TYPES								
PA		Single-Head Area New Pole, Type IV Distribution with House Side Shield	N/A	CLI-NV-1-T4-32L-1-40K7-UNV-XX-XX-XX-HSS	Integrated LED Module, 4000K, 12,826lm, Type IV Distribution, w/Backlite Control, 70CRI	UNI-VAC	106	Single-head Mounted to 20'-0" Existing pole. Engineer to determine required base/pole size/height. Finish TBD.
PB		Single-Head Area New Pole, Type III Distribution	N/A	CLI-NV-1-T3-32L-1-40K7-UNV-XX-XX-XX-HSS	Integrated LED Module, 4000K, 13,038lm, Type III Distribution, w/Backlite Control, 70CRI	UNI-VAC	106	Single-head Mounted to 20'-0" Existing pole. Engineer to determine required base/pole size/height. Finish TBD.
PC		Double-Head Area New Pole, Type V Distribution	N/A	CLI-NV-1-T3-32L-1-40K7-UNV-XX-XX-XX	2-Integrated LED Module, 4000K, (2)13,144lm, Type V Distribution, 70CRI	UNI-VAC	212	Double-heads Mounted to 20'-0" New pole. Engineer to determine required base/pole size/height. Finish TBD.
WA		Wall pack	TBD	CLI-NV-W-T4-16L-7-40K7-UNV-WM-XX-XX-XX	Integrated LED, 4000K, 4,651Lm, Type 4 Distribution	UNI-VAC	37	Direct mounted to building at 100" AFG. Finish TBD.

PLATINUM HORIZON
STREET NUMBER
CITY, ST ZIP

ALL PLANS AND SPECIFICATIONS ARE THE PROPERTY OF COMMERCIAL LIGHTING INC. DO NOT SCALE DRAWINGS. ALL MEASUREMENTS MUST BE CHECKED ON SITE BY THE CONTRACTOR AND ANY DISCREPANCIES BROUGHT TO THE ATTENTION OF THE DESIGNER OR ARCHITECT.

Lighting Plan Site

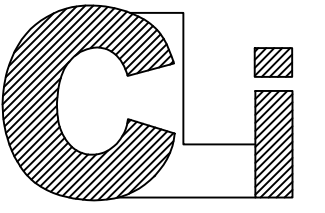

CLI Design
Los Angeles, Miami & New York
Tel: 800-755-0155 | Fax: 760-262-3940

No.	Issue	Date
0.		08.16.2024
1.		10.03.2024

Calculation Summary						
Label	CalcType	Units	Avg	Max	Min	Avg/Min
Property Line	Illuminance	Fc	0.04	0.2	0.0	N.A.
Site Planar	Illuminance	Fc	2.64	9.4	0.8	3.55

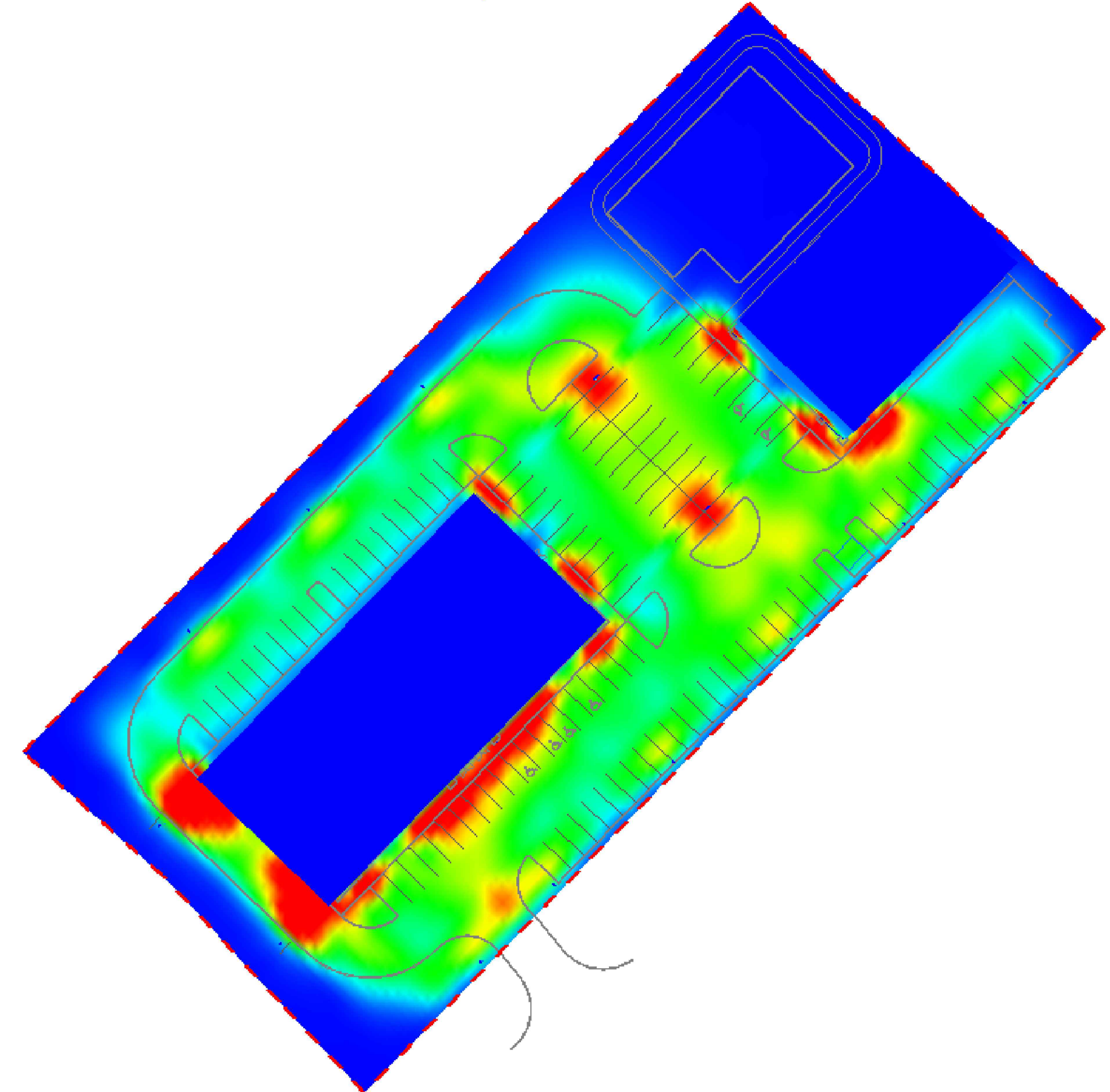
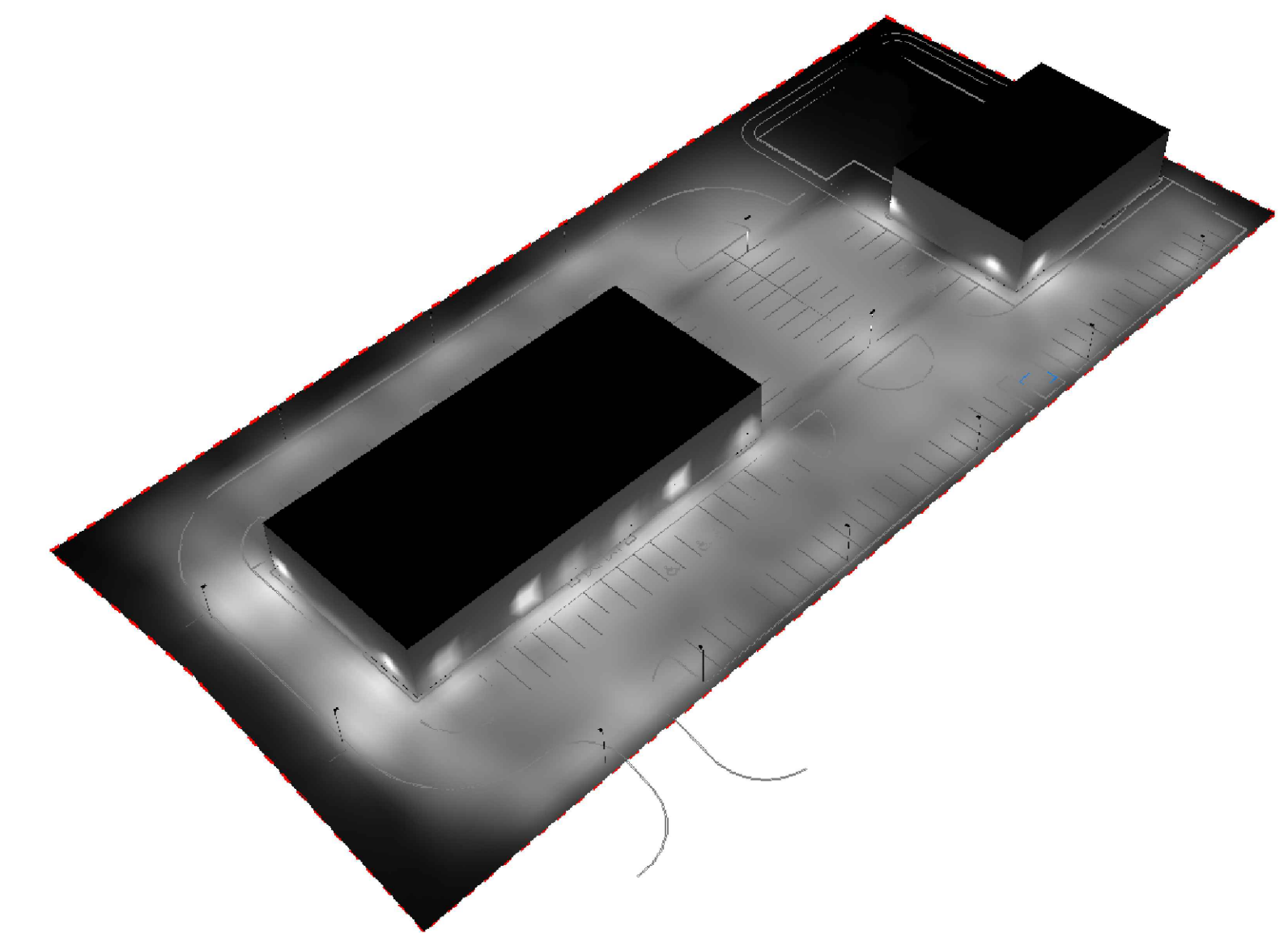
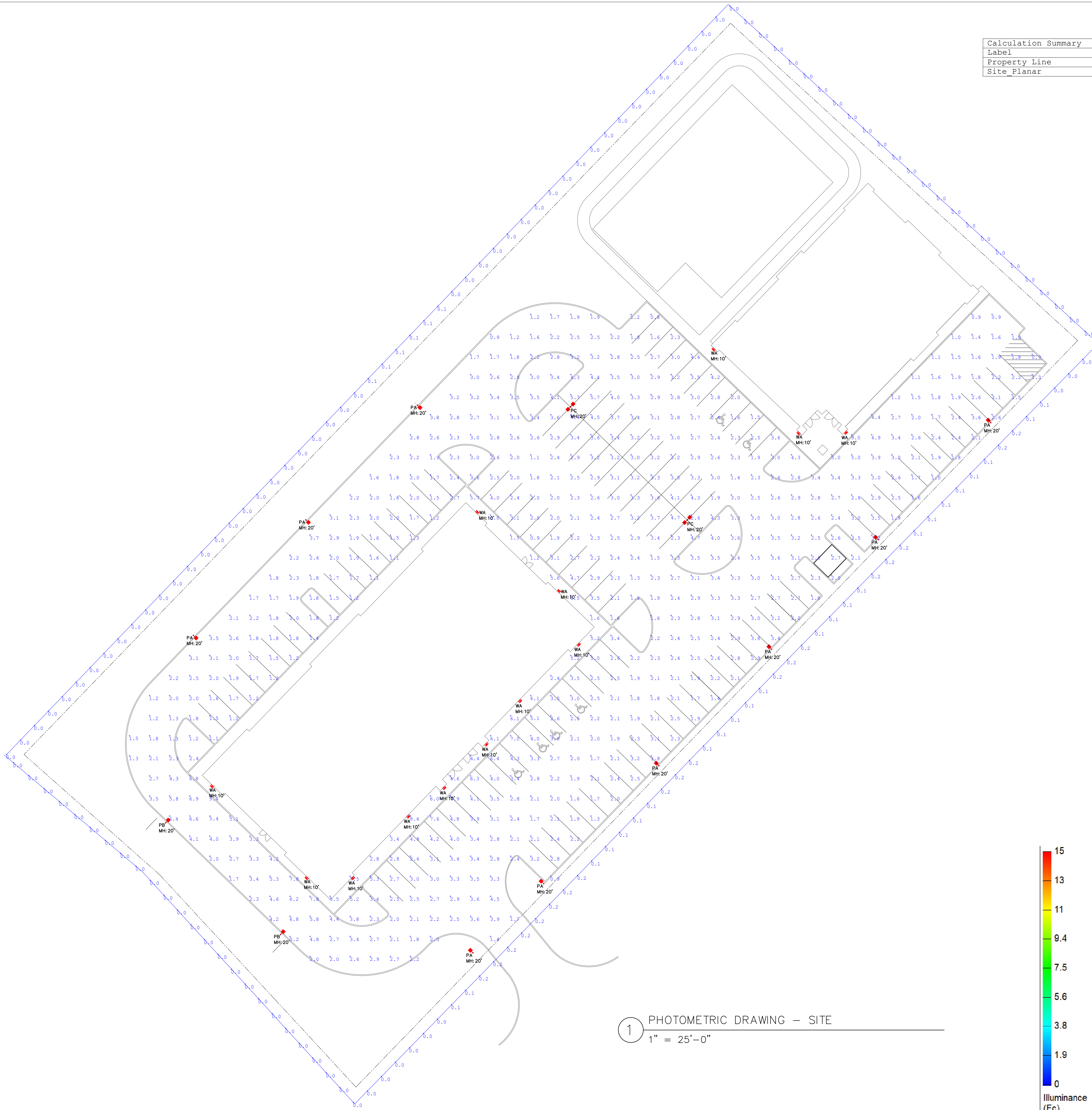

1 PHOTOMETRIC DRAWING – SITE
1" = 25'-0"

PLATINUM HORIZON

STREET NUMBER
CITY, ST, ZIP

ALL PLANS AND SPECIFICATIONS ARE THE PROPERTY OF
COMMERCIAL LIGHTING INC. DO NOT SCALE DRAWINGS.
ALL MEASUREMENTS MUST BE CHECKED ON SITE BY
THE CONTRACTOR AND ANY DISCREPANCIES BROUGHT
TO THE ATTENTION OF THE DESIGNER OR ARCHITECT.

File:

PHOTOMETRIC DRAWING SITE

Scale	Date
AS SHOWN	08.16.2024
Drawn by M.CH	Checked by I.D.
Sheet No.	

LDE-1.2



LED WATTAGE CHART

	16L	32L	48L	64L
400 milliamps	21w	-	-	-
530 milliamps	28w	-	-	-
700 milliamps	36w	71w	104w	136w
1050 milliamps	56w	106w	156w	205w

FORM AND FUNCTION

- Sleek, low profile housing
- Spec grade performance
- Engineered for optimum thermal management
- Low depreciation rate
- Reduces energy consumption and costs up to 65%
- Exceeds IES foot candle levels utilizing the least number of poles and fixtures per project
- Optical system designed for:
 - Parking Lots
 - Auto Dealerships
 - General Area Lighting

CONSTRUCTION

- Die Cast Aluminum
- External cooling fins
- Corrosion resistant external hardware
- One-piece silicone gasket ensures IP65 seal for electronics compartment
- One-piece Optics Plate™ mounting silicone Micro Optics
- Two-piece silicone Micro Optic system ensures IP67 level seal around each PCB
- Grade 2 Clear Anodized Optics Plate™ standard

FINISH

- 3-5 mils electrostatic powder coat.
- NLS' standard high-quality finishes prevent corrosion, protects against extreme environmental conditions

WARRANTY

Five-year limited warranty for drivers and LEDs.

BUY AMERICAN

To ensure the latest BAA/TAA/BABA Standards are being met, please select BAA, TAA, or BABA in the options section. Please contact the factory before placing an order for any NLS products requesting BAA (Buy American Act), TAA (Trade American Act), or BABA (Build America, Buy America).





LED WATTAGE CHART

	16L	32L	48L	64L
400 milliamps	21w	-	-	-
530 milliamps	28w	-	-	-
700 milliamps	36w	71w	104w	136w
1050 milliamps	56w	106w	156w	205w

FORM AND FUNCTION

- Sleek, low profile housing
- Spec grade performance
- Engineered for optimum thermal management
- Low depreciation rate
- Reduces energy consumption and costs up to 65%
- Exceeds IES foot candle levels utilizing the least number of poles and fixtures per project
- Optical system designed for:
 - Parking Lots
 - Auto Dealerships
 - General Area Lighting

CONSTRUCTION

- Die Cast Aluminum
- External cooling fins
- Corrosion resistant external hardware
- One-piece silicone gasket ensures IP65 seal for electronics compartment
- One-piece Optics Plate™ mounting silicone Micro Optics
- Two-piece silicone Micro Optic system ensures IP67 level seal around each PCB
- Grade 2 Clear Anodized Optics Plate™ standard

FINISH

- 3-5 mils electrostatic powder coat.
- NLS' standard high-quality finishes prevent corrosion, protects against extreme environmental conditions

WARRANTY

Five-year limited warranty for drivers and LEDs.

BUY AMERICAN

To ensure the latest BAA/TAA/BABA Standards are being met, please select BAA, TAA, or BABA in the options section. Please contact the factory before placing an order for any NLS products requesting BAA (Buy American Act), TAA (Trade American Act), or BABA (Build America, Buy America).





LED WATTAGE CHART

	16L	32L	48L	64L
400 milliamps	21w	-	-	-
530 milliamps	28w	-	-	-
700 milliamps	36w	71w	104w	136w
1050 milliamps	56w	106w	156w	205w

FORM AND FUNCTION

- Sleek, low profile housing
- Spec grade performance
- Engineered for optimum thermal management
- Low depreciation rate
- Reduces energy consumption and costs up to 65%
- Exceeds IES foot candle levels utilizing the least number of poles and fixtures per project
- Optical system designed for:
 - Parking Lots
 - Auto Dealerships
 - General Area Lighting

CONSTRUCTION

- Die Cast Aluminum
- External cooling fins
- Corrosion resistant external hardware
- One-piece silicone gasket ensures IP65 seal for electronics compartment
- One-piece Optics Plate™ mounting silicone Micro Optics
- Two-piece silicone Micro Optic system ensures IP67 level seal around each PCB
- Grade 2 Clear Anodized Optics Plate™ standard

FINISH

- 3-5 mils electrostatic powder coat.
- NLS' standard high-quality finishes prevent corrosion, protects against extreme environmental conditions

WARRANTY

Five-year limited warranty for drivers and LEDs.

BUY AMERICAN

To ensure the latest BAA/TAA/BABA Standards are being met, please select BAA, TAA, or BABA in the options section. Please contact the factory before placing an order for any NLS products requesting BAA (Buy American Act), TAA (Trade American Act), or BABA (Build America, Buy America).



Project Name:

Type:

NV-1 ORDERING GUIDE

Cat#	Light Dist.	# of LEDs	Miliamps	Kelvin	Volts
NV-1 (NV-1)	Type 2 (T2)	16 (16L)	400 (40)	Amber 586-600nM (AMBER) ^{10, 12, 13}	120-277 (UNV)
	Type 3 (T3)	32 (32L) ¹⁵	530 (53)	2700K, 70 CRI (27K7) ⁶	347-480 (HV)
	Type 4 (T4)	48 (48L) ¹⁵	700 (7)	2700K, 80 CRI (27K8) ^{1, 6}	
	Type 5 (T5)	64 (64L) ¹⁵	1050 (1)	3000K, 70 CRI (30K7) ⁶	
	Nema 3 30o Narrow Beam (N3)			3000K, 80 CRI (30K8) ^{1, 6}	
	Corner Distribution Left (CDL)			3500K, 80 CRI (35K8) ¹	
	Corner Distribution Right (CDR)			4000K, 70 CRI (40K7)	
				4000K, 80 CRI (40K8) ¹	
				5000K, 70 CRI (50K7)	
				5000K, 80 CRI (50K8) ¹	
Mounting	Color	Controls Options	Options	Lens Options	
Architectural Sweep Arm (ASA)	Bronze Textured (BRZ)	Nema 7-Pin Receptacle (PE7)	Bird Spikes (BS)	Glass Lens (GL) ^{7, 14}	
Direct Pole 3" Arm Single D180 (DPS3) ²	White Textured (WHT)	Photocell + Receptacle (PCR)	Marine Grade Finish (MGF)	HAL Lens (HAL) ^{8, 14}	
Direct Pole 7" Arm D180, D90, T90, T120, Quad (DPS7) ²	Smooth White Gloss (SWT)	Receptacle + Shorting Cap (PER)	Optic Plate Painted to Match Fixture (OPP)		
Knuckle Mount (KM)	Silver Metallic (SVR)	FSP-211 with Motion Sensor 9'-20' Heights (FSP-20) ⁴	Quick Mount Bracket (QMB)		
Wall Mount (WM)	Black Textured (BLK)	21'-40' Heights (FSP-40) ⁴	Retrofit Mount Bracket (RQMB)		
Trunnion Mount (TM) ³	Smooth Black Gloss (SBK)	Custom Controls Integration (CCI) ⁹	Round Pole Adaptor 3"-4" Pole (RPA4)		
Tennis Arm Mount (TA)	Graphite Textured (GPH)	Button Type Photocell (PC) ⁴	Round Pole Adaptor 5"-6" Pole (RPA5)		
Mast Arm Mount (MA)	Grey Textured (GRY)		Rotated Optic Left (ROL)		
	Green Textured (GRN)		Rotated Optic Right (ROR)		
	Hunter Green Textured (HGN)		House Side Shield (HSS) ⁵		
	Custom (CS)		Black Hardware (BH)		
			Black Optic Frame (BOF)		
			Buy American Act (BAA) ¹¹		
			Trade Agreement Act (TAA) ¹¹		
			Build America Buy American (BABA) ¹¹		

NOTES:

1. Consult Factory for Lead Time. Consult Factory for 90 CRI Requests.
2. For Round Pole Specify RPA4 or RPA5
3. Standard finish is stainless steel. Can be painted to match fixture.
4. Universal Voltage 120-277
5. HSS not applicable with Nema 2.
6. 3000K or lower, with fixed mounting options only, must be selected to meet International Dark-Sky Association certification.
7. Glass Lens: Low iron glass, fully tempered per ANSI C1047 (QCH-2201-37)
8. HAL Lens: Yellow Polycarbonate Lens – less than 2% Blue Light Content
9. Please contact Factory for Custom Control Integration requests (nLight, NX, WaveLinx, Crestron, DMX/RDM, Synapse, Casambi, Dali II, Avi-On, or other control systems)
10. Turtle Safe
11. Consult factory for all BAA/TAA/BABA requests
12. Consult Factory for Lead Time
13. Not Available above 1000mA
14. Contact Factory
15. Available only in 700mA and 1050mA



701 Kingshill Place, Carson, CA 90746
Call Us Today (310) 341-2037

nlsighting.com

PRODUCT SPECIFICATIONS

ELECTRICAL

- 120-277 Volts (UNV) or 347-480 Volts (HV)
- 0-10V dimming driver
- Driver power factor at maximum load is $\geq .95$, THD maximum load is 15%
- LED Drivers Ambient Temp. Min is -40°C and Ambient Temp. Max ranges from 50°C to 55°C and, in some cases, even higher. Consult the factory for revalidation by providing the fixture catalog string before quoting and specifying it
- All internal wiring UL certified for 600 VAC and 105°C
- All drivers, controls, and sensors housed in enclosed IP65 compartment
- CRI 70, 80 or 90 (Contact factory for 90 CRI)
- Color temperatures: Amber, 2700K, 3000K, 3500K, 4000K, 5000K
- Surge Protection: 20KVA supplied as standard

CONSTRUCTION

- Die Cast Aluminum
- External cooling fins
- Corrosion resistant external hardware
- One-piece silicone gasket ensures IP65 seal for electronics compartment
- One-piece Optics Plate™ mounting silicone Micro Optics
- Two-piece silicone Micro Optic system ensures IP67 level seal around each PCB
- Grade 2 Clear Anodized Optics Plate™ standard

OPTIONS

- BIRD SPIKES (BS) - Offers a practical and humane deterrent for larger bird species and provides a cost-effective long-term solution to nuisance bird infestations and protects your property
- MARINE GRADE FINISH (MGF) - A multi-step process creating protective finishing coat against harsh environments. Chemically washed in a 5 stage cleaning system. Pre-baked, Powder coated 3-5 mils of Zinc Rich Super Durable Polyester Primer. Oven Baked. Finished Powder Coating of Super Durable Polyester Powder Coat 3-5 mil thickness
- OPTIC PLATE PAINTED TO MATCH FIXTURE (OPP) - Optic plate is clear anodized as standard. The optic plate can be powder coated to match the finish of the fixture.
- QUICK MOUNT BRACKET (QMB) - Optional Cast Aluminum Bracket designed for quick mounting on Direct Square or Round Poles. Cleat mounts directly to pole for easily hung fixtures. Has a 2"x4" Drill Pattern
- RETROFIT MOUNT BRACKET - Optional Cast Aluminum Bracket designed for quick mounting on Direct Square or Round Poles. Cleat mounts directly to pole for easily hung fixtures. Drill Pattern is adjustable from 2"x4" to 2"x6"
- ROUND POLE ADAPTER (RPA) - When using round poles, specify Round Pole Adapter (RPA). Specify RPA4 when installing on 3"-4" round poles, and RPA5 when installing on 5"-6" round poles
- ROTATED OPTICS (ROL) (ROR) - Rotated optics are designed for perimeter lighting for auto dealerships
- HOUSE SIDE SHIELD (HSS) Designed for full property line cut-off
- BLACK HARDWARE (BH) - Optional black, zinc coated steel hardware
- BLACK OPTIC FRAME (BOF) - Optional black optic frame. Standard is white
- GLASS LENS (GL) - Low Iron Glass, fully tempered
- High performance amber lens (hal)

CONTROL OPTIONS

- FSP-211 (FSP-X) - Passive infrared (PIR) sensor providing multi-level control based on motion/daylight contribution
- All control parameters adjustable via wireless configuration remote storing and transmitting sensor profiles
- FSP-20 mounting heights 9-20 feet
- FSP-40 mounting heights 21-40 feet
- Includes 5 dimming event cycles, 0-10V dimming with motion sensing, re-programmable in the field
- FSIR-100 commissioning remote is required to change sensor settings. Please contact factory for ordering
- NEMA 7-PIN RECEPTACLE (PE7)—An ANSI C136.41-2013 receptacle provides electrical and mechanical interconnection between photo control cell and luminaire. Dimming receptacle available two or four dimming contacts supports 0-10 VDC dimming methods or Digital Addressable Lighting Interface (DALI), providing reliable power interconnect
- PHOTOCCELL + RECEPTACLE (PCR)—7-Pin Receptacle and Electronic Twist Lock Photocell for dusk to dawn operation
- RECEPTACLE + SHORTING CAP (PER)—7-Pin Receptacle and Shorting Cap
- Controls Agnostic: Please contact factory for your preferred controls option. (nLight, NX, WaveLinx, Crestron, DMX/RDM, Synapse, Casambi, DALI II, Avi-On, or other control systems)

FINISH

- 3-5 mils electrostatic powder coat
- NLS Light's standard high-quality finishes prevent corrosion protects against and extreme environmental conditions

WARRANTY

Five-year limited warranty for drivers and LEDs.

OPTICS

Silicone optics high thermal stability and light output provide higher powered LEDs with minimized lumen depreciation. UV stability with scratch resistance increases exterior application durability. Silicone optics do not yellow, crack or brittle over time

LISTINGS

- Certified to UL 1598
- UL 8750
- CSA C22.2 No. 250.0
- DesignLights Consortium® (DLC)
- DesignLights Consortium Premium® (DLCP)
- IP65/ IP67 Rated
- 3G Vibration Rated per ANSI C136.31-2010
- IDA Dark Sky Approved
- IK10 Rated

BUY AMERICAN OPTION

While all of the NLS Lighting products listed in this document qualify for the Buy America(n) Act of 1933, we reserve the right to change our listings without notice.

The information provided above is for general informational purposes only. We encourage you to consult legal professionals for advice particular to your projects concerning BAA, TAA, BABA or Buy America.

Additional NLS Products that meet BAA, TAA standards can be found at the following link:

<https://nlsighting.com/buy-american/>



The information and specifications on this document are subject to change without any notification. All values are design, nominal, typical or prorated values when measured under internal and external laboratory conditions.



701 Kingshill Place, Carson, CA 90746
Call Us Today (310) 341-2037

nlsighting.com

PRODUCT SPECIFICATIONS

LUMENS CHART 16L, 32L, & 48L

CAT#	N3	LM/W	T2	LM/W	T3	LM/W	T4	LM/W	T5	LM/W	W
NV-1-16L-40-27K7	1,749	83	2,324	111	2,342	112	2,307	110	2,360	112	21
NV-1-16L-40-30K7	2,037	97	2,333	111	2,532	121	2,316	110	2,552	122	21
NV-1-16L-40-40K7	2,436	116	2,715	129	2,736	130	2,695	128	2,757	131	21
NV-1-16L-40-50K7	2,520	120	2,715	129	2,736	130	2,695	128	2,757	131	21
NV-1-16L-53-27K7	2,543	91	2,588	92	3,015	108	2,920	104	3,041	109	28
NV-1-16L-53-30K7	3,136	112	3,192	114	3,220	115	3,119	111	3,248	116	28
NV-1-16L-53-40K7	3,248	116	3,472	124	3,472	124	3,444	123	3,500	125	28
NV-1-16L-53-50K7	3,360	120	3,612	129	3,640	130	3,584	128	3,668	131	28
NV-1-16L-7-27K7	3,269	91	3,327	92	3,876	108	3,755	104	3,910	109	36
NV-1-16L-7-30K7	4,032	112	3,960	110	3,960	110	3,973	110	3,996	111	36
NV-1-16L-7-40K7	4,176	116	4,428	123	4,284	119	4,212	117	4,320	120	36
NV-1-16L-7-50K7	4,320	120	4,644	129	4,500	125	4,428	123	4,500	125	36
NV-1-16L-1-27K7	5,085	91	5,176	92	6,030	108	5,841	104	6,082	109	56
NV-1-16L-1-30K7	6,272	112	6,160	110	6,384	114	6,232	111	6,440	115	56
NV-1-16L-1-40K7	6,496	116	6,832	122	6,888	123	6,776	121	6,944	124	56
NV-1-16L-1-50K7	6,720	120	7,168	128	7,224	129	7,112	127	7,280	130	56
NV-1-32L-7-27K7	6,447	91	7,313	103	7,313	103	7,246	102	7,379	104	71
NV-1-32L-7-30K7	7,952	112	7,810	110	7,810	110	7,739	109	7,881	111	71
NV-1-32L-7-40K7	8,236	116	9,017	127	8,449	119	8,307	117	8,520	120	71
NV-1-32L-7-50K7	8,520	120	9,159	129	8,875	125	8,733	123	8,946	126	71
NV-1-32L-1-27K7	11,116	105	10,917	103	11,314	107	11,067	104	11,414	108	106
NV-1-32L-1-30K7	11,872	112	11,660	110	12,084	114	11,820	112	12,190	115	106
NV-1-32L-1-40K7	12,296	116	12,932	122	13,038	123	12,826	121	13,144	124	106
NV-1-32L-1-50K7	12,720	120	13,568	128	13,674	129	13,462	127	13,780	130	106
NV-1-48L-7-27K7	10,906	105	10,711	103	10,711	103	10,614	102	10,809	104	104
NV-1-48L-7-30K7	11,648	112	11,440	110	11,440	110	11,336	109	11,544	111	104
NV-1-48L-7-40K7	12,064	116	13,208	127	12,376	119	12,168	117	12,480	120	104
NV-1-48L-7-50K7	12,480	120	13,520	130	13,000	125	12,792	123	13,104	126	104
NV-1-48L-1-27K7	16,359	105	16,067	103	16,651	107	16,359	105	16,798	108	156
NV-1-48L-1-30K7	17,472	112	17,160	110	17,784	114	17,472	112	17,940	115	156
NV-1-48L-1-40K7	18,096	116	19,032	122	19,188	123	18,876	121	19,344	124	156
NV-1-48L-1-50K7	18,720	120	19,968	128	20,124	129	19,812	127	20,280	130	156

3000K or lower, with fixed mounting options only, must be selected to meet International Dark-Sky Association certification.

LUMENS CHART 64L ONLY

CAT#	N3	LM/W	T2	LM/W	T3	LM/W	T4	LM/W	T5	LM/W	CDL*	LM/W	CDR*	LM/W	W
NV-1-64L-7-27K7	14,262	105	14,007	103	14,007	103	13,880	102	14,135	104	5,797	43	5,725	42	136
NV-1-64L-7-30K7	15,232	112	14,960	110	14,960	110	14,824	109	15,096	111	6,191	46	6,190	46	136
NV-1-64L-7-40K7	15,776	116	17,272	127	16,184	119	15,912	117	16,320	120	6,689	49	6,689	49	136
NV-1-64L-7-50K7	16,320	120	17,680	130	17,000	125	16,728	123	17,136	126	7,013	52	6,689	49	136
NV-1-64L-1-27K7	21,252	106	21,114	106	21,882	109	21,498	107	22,074	110	8,695	43	8,588	43	200
NV-1-64L-1-30K7	22,960	115	22,550	113	23,370	117	22,960	115	23,575	118	9,286	46	9,286	46	200
NV-1-64L-1-40K7	23,780	119	25,010	125	25,215	126	24,805	124	25,420	127	10,034	50	10,033	50	200
NV-1-64L-1-50K7	24,600	123	26,240	131	26,445	132	26,035	130	26,650	133	10,519	53	10,033	50	200

3000K or lower, with fixed mounting options only, must be selected to meet International Dark-Sky Association certification.

LUMEN MAINTENANCE DATA

Ambient Temperature	Drive Current	L90 Hours*	L70 Hours**	30,000 Hours*	50,000 Hours*	60,000 Hours*	100,000 Hours**
25°C	Up to 700mA	58,000	173,000	95.7%	91.6%	89.6%	82.1%
	1050mA	48,000	143,000	94.3%	89.5%	87.2%	78.5%

*Reported extrapolations per IESNA TM-21

**Projected extrapolations per IESNA TM-21

MULTIPLIERS FOR 70/80 CRI (Scaling Factor of 5000K 70 CRI)

CRI	70 CRI	80 CRI
2700K	0.8560	0.8015
3000K	-	0.8594
3500K	-	0.8594
4000K	-	0.9255
5000K	-	0.9255



701 Kingshill Place, Carson, CA 90746
Call Us Today (310) 341-2037

nlsighting.com

PRODUCT SPECIFICATIONS

BUG RATINGS 16L, 32L, & 48L

CAT#	T2	T3	T4	T5
NV-1-16L-40-27K7	B1-U0-G1	B1-U0-G1	B1-U0-G1	B2-U0-G0
NV-1-16L-40-30K7	B1-U0-G1	B1-U0-G1	B1-U0-G1	B2-U0-G0
NV-1-16L-40-40K7	B1-U0-G1	B1-U0-G1	B1-U0-G1	B2-U0-G1
NV-1-16L-40-50K7	B1-U0-G1	B1-U0-G1	B1-U0-G1	B2-U0-G1
NV-1-16L-53-27K7	B1-U0-G1	B1-U0-G1	B1-U0-G1	B2-U0-G1
NV-1-16L-53-30K7	B1-U0-G1	B1-U0-G1	B1-U0-G1	B2-U0-G1
NV-1-16L-53-40K7	B1-U0-G1	B1-U0-G1	B1-U0-G1	B2-U0-G1
NV-1-16L-53-50K7	B1-U0-G1	B1-U0-G1	B1-U0-G1	B2-U0-G1
NV-1-16L-7-27K7	B1-U0-G1	B1-U0-G1	B1-U0-G1	B3-U0-G1
NV-1-16L-7-30K7	B1-U0-G1	B1-U0-G1	B1-U0-G1	B3-U0-G1
NV-1-16L-7-40K7	B1-U0-G1	B1-U0-G1	B1-U0-G1	B3-U0-G1
NV-1-16L-7-50K7	B1-U0-G1	B1-U0-G1	B1-U0-G1	B3-U0-G1
NV-1-16L-1-27K7	B1-U0-G1	B1-U0-G1	B1-U0-G1	B3-U0-G1
NV-1-16L-1-30K7	B1-U0-G1	B1-U0-G1	B1-U0-G1	B3-U0-G1
NV-1-16L-1-40K7	B1-U0-G1	B2-U0-G2	B2-U0-G2	B3-U0-G2
NV-1-16L-1-50K7	B1-U0-G2	B2-U0-G2	B2-U0-G2	B3-U0-G2
NV-1-32L-7-27K7	B1-U0-G2	B2-U0-G2	B2-U0-G2	B3-U0-G2
NV-1-32L-7-30K7	B1-U0-G2	B2-U0-G2	B2-U0-G2	B3-U0-G2
NV-1-32L-7-40K7	B1-U0-G2	B2-U0-G2	B2-U0-G2	B3-U0-G2
NV-1-32L-7-50K7	B2-U0-G2	B2-U0-G2	B2-U0-G2	B3-U0-G2
NV-1-32L-1-27K7	B2-U0-G2	B2-U0-G2	B2-U0-G2	B4-U0-G2
NV-1-32L-1-30K7	B2-U0-G2	B2-U0-G2	B2-U0-G2	B4-U0-G2
NV-1-32L-1-40K7	B2-U0-G2	B2-U0-G2	B3-U0-G2	B4-U0-G2
NV-1-32L-1-50K7	B2-U0-G2	B3-U0-G3	B3-U0-G3	B4-U0-G2
NV-1-48L-7-27K7	B2-U0-G2	B2-U0-G2	B2-U0-G2	B4-U0-G2
NV-1-48L-7-30K7	B2-U0-G2	B2-U0-G2	B2-U0-G2	B4-U0-G2
NV-1-48L-7-40K7	B2-U0-G2	B2-U0-G2	B2-U0-G2	B4-U0-G2
NV-1-48L-7-50K7	B2-U0-G2	B3-U0-G3	B3-U0-G3	B4-U0-G2
NV-1-48L-1-27K7	B3-U0-G3	B3-U0-G3	B3-U0-G3	B4-U0-G2
NV-1-48L-1-30K7	B3-U0-G3	B3-U0-G3	B3-U0-G3	B4-U0-G2
NV-1-48L-1-40K7	B3-U0-G3	B3-U0-G3	B3-U0-G3	B5-U0-G3
NV-1-48L-1-50K7	B3-U0-G3	B3-U0-G3	B3-U0-G3	B5-U0-G3

3000K or lower, with fixed mounting options only, must be selected to meet International Dark-Sky Association certification.

BUG RATINGS 64L

CAT#	T2	T3	T4	T5	CDL*	CDR*
NV-1-64L-7-27K7	B2-U0-G2	B3-U0-G3	B3-U0-G3	B4-U0-G2	B1-U0-G2	B1-U0-G2
NV-1-64L-7-30K7	B2-U0-G2	B3-U0-G3	B3-U0-G3	B4-U0-G2	B1-U0-G2	B1-U0-G2
NV-1-64L-7-40K7	B3-U0-G3	B3-U0-G3	B3-U0-G3	B4-U0-G2	B1-U0-G2	B1-U0-G2
NV-1-64L-7-50K7	B3-U0-G3	B3-U0-G3	B3-U0-G3	B4-U0-G2	B1-U0-G2	B1-U0-G2
NV-1-64L-1-27K7	B3-U0-G3	B3-U0-G3	B3-U0-G3	B5-U0-G3	B1-U0-G2	B1-U0-G2
NV-1-64L-1-30K7	B3-U0-G3	B3-U0-G3	B3-U0-G3	B5-U0-G3	B1-U0-G2	B1-U0-G2
NV-1-64L-1-40K7	B3-U0-G3	B3-U0-G3	B3-U0-G4	B5-U0-G3	B1-U0-G2	B1-U0-G2
NV-1-64L-1-50K7	B3-U0-G3	B3-U0-G3	B3-U0-G4	B5-U0-G3	B1-U0-G2	B1-U0-G2

3000K or lower, with fixed mounting options only, must be selected to meet International Dark-Sky Association certification.

*64L Only



701 Kingshill Place, Carson, CA 90746
Call Us Today (310) 341-2037

nlsighting.com

PRODUCT SPECIFICATIONS

LUMEN HSS

PART NUMBER	T2 HSS	LM/W	BUG	T3 HSS	LM/W	BUG	T4 HSS	LM/W	BUG	W
NV-1-16L-40-27K7	1386	66	B0-U0-G0	1336	64	B0-U0-G0	1343	64	B0-U0-G0	21
NV-1-16L-40-30K7	1499	71	B0-U0-G0	1445	69	B0-U0-G0	1452	69	B0-U0-G0	21
NV-1-16L-40-40K7	1620	77	B0-U0-G0	1561	74	B0-U0-G0	1569	75	B0-U0-G0	21
NV-1-16L-40-50K7	1620	77	B0-U0-G0	1561	74	B0-U0-G0	1569	75	B0-U0-G0	21
NV-1-16L-530-27K7	1837	66	B0-U0-G0	1771	63	B0-U0-G0	1780	64	B0-U0-G1	28
NV-1-16L-530-30K7	1986	71	B0-U0-G0	1914	68	B0-U0-G1	1924	69	B0-U0-G1	28
NV-1-16L-530-40K7	2146	77	B0-U0-G0	2068	74	B0-U0-G1	2079	74	B0-U0-G1	28
NV-1-16L-530-50K7	2146	77	B0-U0-G0	2068	74	B0-U0-G1	2079	74	B0-U0-G1	28
NV-1-16L-700-27K7	2426	67	B0-U0-G1	2338	65	B0-U0-G1	2350	65	B0-U0-G1	36
NV-1-16L-700-30K7	2623	73	B0-U0-G1	2528	70	B0-U0-G1	2541	71	B0-U0-G1	36
NV-1-16L-700-40K7	2835	79	B0-U0-G1	2732	76	B0-U0-G1	2746	76	B0-U0-G1	36
NV-1-16L-700-50K7	2835	79	B0-U0-G1	2732	76	B0-U0-G1	2746	76	B0-U0-G1	36
NV-1-16L-1050-27K7	3639	65	B0-U0-G1	3508	63	B0-U0-G1	3526	63	B0-U0-G1	56
NV-1-16L-1050-30K7	3935	70	B1-U0-G1	3792	68	B0-U0-G1	3812	68	B0-U0-G1	56
NV-1-16L-1050-40K7	4252	76	B1-U0-G1	4098	73	B0-U0-G1	4119	74	B0-U0-G1	56
NV-1-16L-1050-50K7	4252	76	B1-U0-G1	4098	73	B0-U0-G1	4119	74	B0-U0-G1	56
NV-1-32L-700-27K7	4853	68	B1-U0-G1	4677	66	B0-U0-G1	4701	66	B0-U0-G1	71
NV-1-32L-700-30K7	5247	74	B1-U0-G1	5057	71	B0-U0-G1	5083	72	B1-U0-G2	71
NV-1-32L-700-40K7	5669	80	B1-U0-G1	5464	77	B0-U0-G2	5492	77	B1-U0-G2	71
NV-1-32L-700-50K7	5669	80	B1-U0-G1	5464	77	B0-U0-G2	5492	77	B1-U0-G2	71
NV-1-32L-1050-27K7	7279	69	B1-U0-G2	7015	66	B1-U0-G2	7051	67	B1-U0-G2	106
NV-1-32L-1050-30K7	7870	74	B1-U0-G2	7585	72	B1-U0-G2	7624	72	B1-U0-G2	106
NV-1-32L-1050-40K7	8504	80	B1-U0-G2	8196	77	B1-U0-G2	8238	78	B1-U0-G2	106
NV-1-32L-1050-50K7	8504	80	B1-U0-G2	8196	77	B1-U0-G2	8238	78	B1-U0-G2	106
NV-1-48L-700-27K7	7279	70	B1-U0-G2	7015	67	B1-U0-G2	7051	68	B1-U0-G2	104
NV-1-48L-700-30K7	7870	76	B1-U0-G2	7585	73	B1-U0-G2	7624	73	B1-U0-G2	104
NV-1-48L-700-40K7	8504	82	B1-U0-G2	8196	79	B1-U0-G2	8238	79	B1-U0-G2	104
NV-1-48L-700-50K7	8504	82	B1-U0-G2	8196	79	B1-U0-G2	8238	79	B1-U0-G2	104
NV-1-48L-1050-27K7	10918	70	B1-U0-G2	10523	67	B1-U0-G2	10577	68	B1-U0-G2	156
NV-1-48L-1050-30K7	11805	76	B1-U0-G2	11377	73	B1-U0-G2	11436	73	B1-U0-G2	156
NV-1-48L-1050-40K7	12755	82	B1-U0-G2	12293	79	B1-U0-G2	12356	79	B1-U0-G2	156
NV-1-48L-1050-50K7	12755	82	B1-U0-G2	12293	79	B1-U0-G2	12356	79	B1-U0-G2	156
NV-1-64L-700-27K7	9705	71	B1-U0-G2	9354	69	B1-U0-G2	9402	69	B1-U0-G2	136
NV-1-64L-700-30K7	10493	77	B1-U0-G2	10113	74	B1-U0-G2	10165	75	B1-U0-G2	136
NV-1-64L-700-40K7	11338	83	B1-U0-G2	10927	80	B1-U0-G2	10983	81	B1-U0-G2	136
NV-1-64L-700-50K7	11338	83	B1-U0-G2	10927	80	B1-U0-G2	10983	81	B1-U0-G2	136
NV-1-64L-1050-27K7	14558	71	B1-U0-G2	14031	68	B1-U0-G2	14103	69	B1-U0-G3	205
NV-1-64L-1050-30K7	15740	77	B1-U0-G2	15170	74	B1-U0-G3	15248	74	B1-U0-G3	205
NV-1-64L-1050-40K7	17007	83	B2-U0-G2	16391	80	B1-U0-G3	16475	80	B1-U0-G3	205
NV-1-64L-1050-50K7	17007	83	B2-U0-G2	16391	80	B1-U0-G3	16475	80	B1-U0-G3	205

3000K or lower, with fixed mounting options only, must be selected to meet International Dark-Sky Association certification.



701 Kingshill Place, Carson, CA 90746
Call Us Today (310) 341-2037

nlsighting.com

PRODUCT SPECIFICATIONS

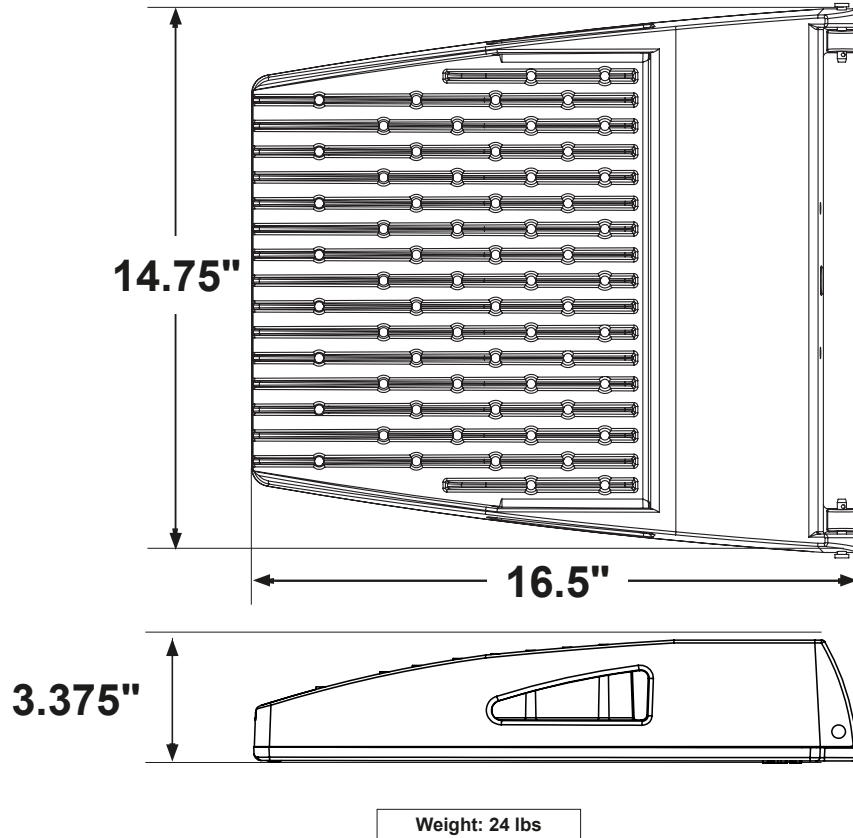

Weight: 24 lbs

OPTICAL CONFIGURATIONS

Rotatable Optics (ROR) Rotated Right, (ROL) Rotated Left options available. Optics field and factory rotatable.

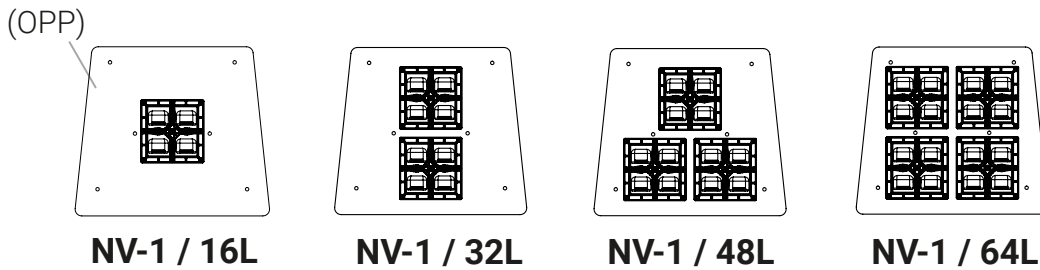

* OPTIC PLATE PAINTED TO MATCH FIXTURE FINISH (OPP)– Optic Plate standard clear anodized, Grade 2. When (OPP) specified, Optic Plate finish will match fixture finish.

OPTICS

Silicone optics high photothermal stability and light output provides higher powered LEDs with minimized lumen depreciation LED life. UV and thermal stability with scratch resistance increases exterior application durability.

IES Types

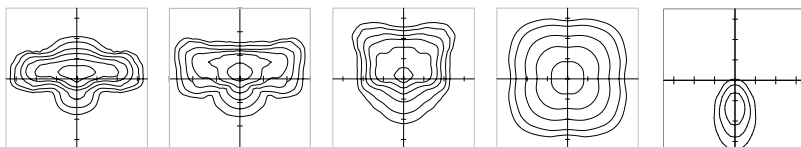

TYPE II (T2)

TYPE III (T3)

TYPE IV (T4)

TYPE V (T5)

NEMA 3 (N3)

PRODUCT SPECIFICATIONS

OPTICAL CONFIGURATIONS (CONTINUED) - Corner Optics (CDL/CDR)

Blended optical distributions include a HSS over the optic and are aimed forward.
Fixtures also feature an external side mounted shield.

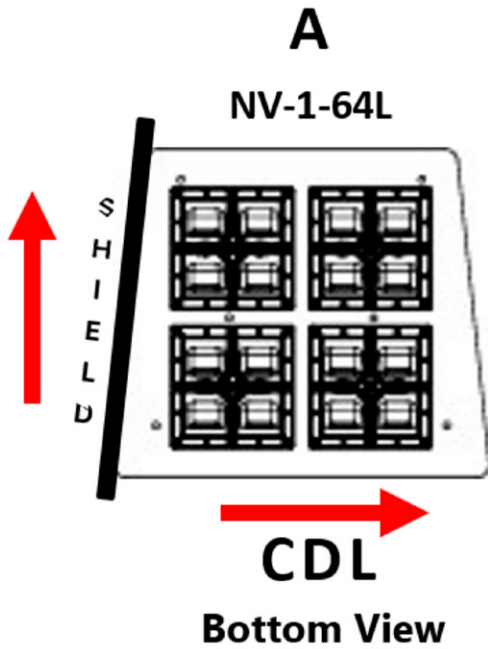

NV-64L-1-40K-CDL (205 Watts, 49LPW)

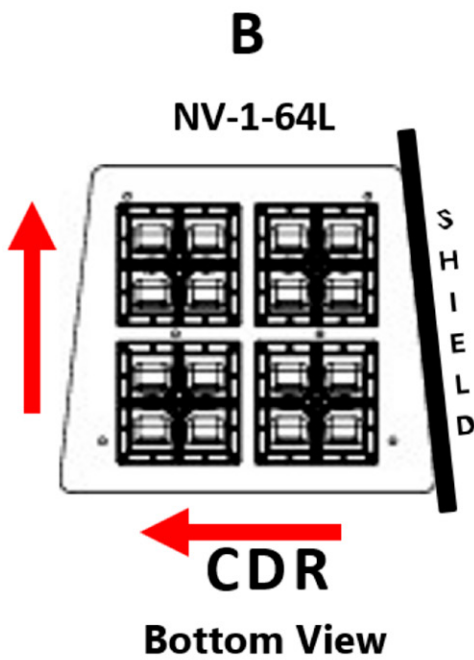
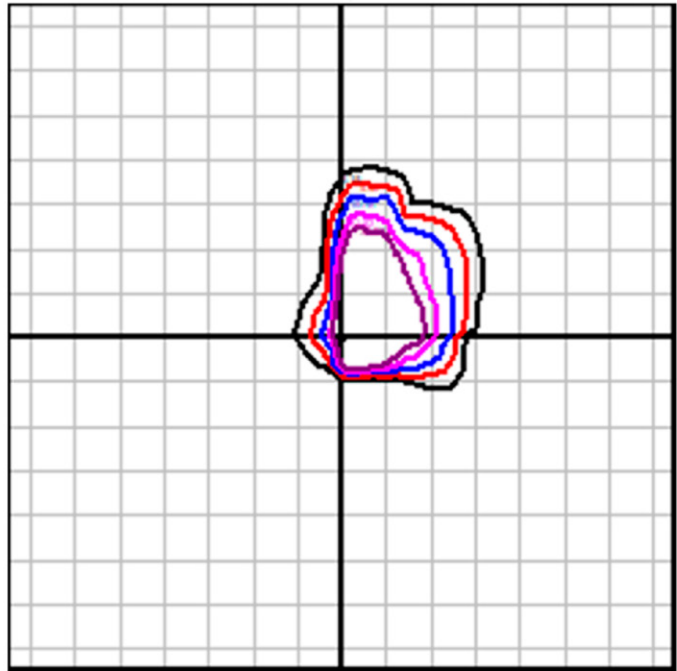

NV-64L-1-40K-CDR (205 Watts, 49LPW)

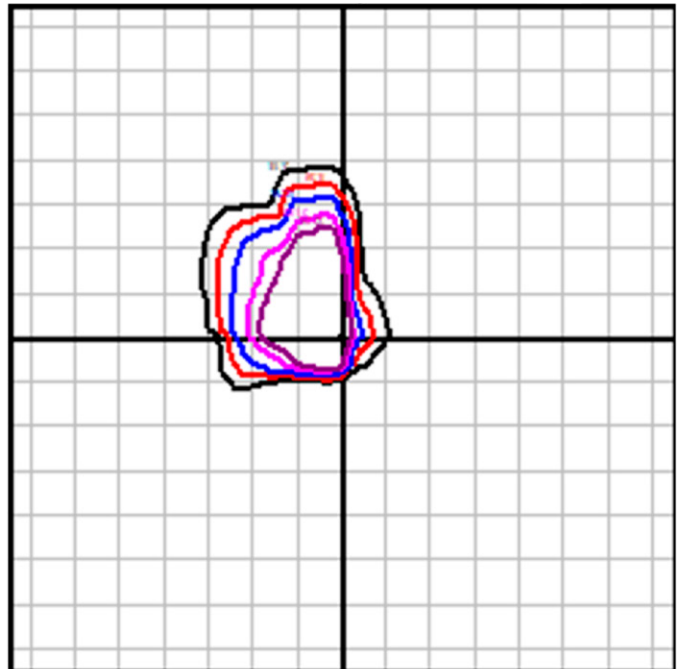

PRODUCT SPECIFICATIONS

MOUNTING OPTIONS

ARCHITECTURAL SWEEP ARM (ASA)

Cast Sweep Arm includes (as standard)
Internal Quick Mount Bracket.

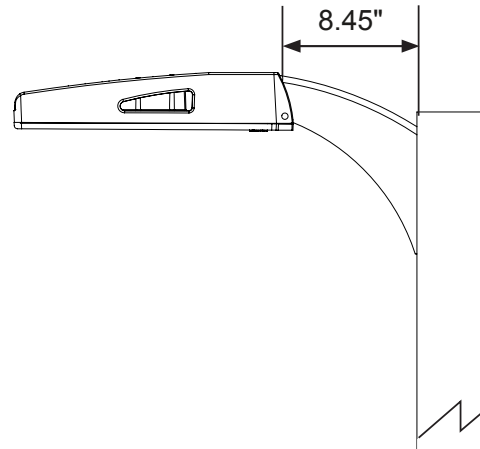

DIRECT POLE (DP)

Standard mounting arm is extruded
aluminum in lengths of 3" and 7".

*Arm lengths may vary depending on configuration

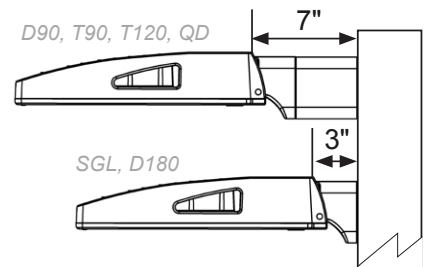

DPX ARM LENGTH

DPX ARM LENGTH	SGL	D90	D180	D180	T90	T120	QD
NV-1	3"	7"	3"	7"	7"	7"	7"

WALL MOUNT (WM)

Cast Aluminum Plate for direct wall mount.
3" extruded aluminum arm mounts directly
to a cast wall mount box.

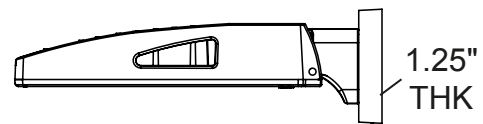

EPA

EPA	SGL	D90	D180	T90	T120	QD
NV-1-DP3	0.46	-	0.92	-	-	-
NV-1-DP7	-	1.14	1.05	1.34	1.37	1.34
NV-1-KM	0.54	N/A	1.08	N/A	N/A	N/A
NV-1-ASA	0.75	1.29	1.50	1.99	2.05	1.99

MOUNTING CONFIGURATION

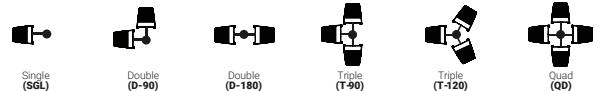

PRODUCT SPECIFICATIONS

MOUNTING OPTIONS

TRUNNION MOUNT (TM)

Steel, bolt-on-mounting for adjustable installation with a maximum uplift of 90 degrees.

**Unpainted stainless steel is standard*

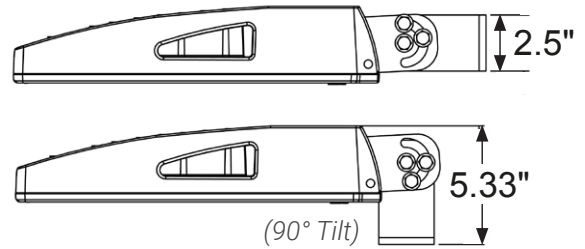

TENNIS ARM (TA)

Steel fitter slips over 3.5" x 1.5" rectangular arm. *See Tennis Arm Spec Sheet for details

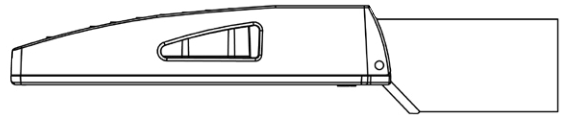

KNUCKLE MOUNT (KM)

Die Cast Knuckle great for adjustable installation on 2-3/8" OD vertical or horizontal tenon.

- Max Up-tilt of 90 degrees
- Adjustable in 6 degree increments
- 1.5G Vibration Rated per ANSI C136.31-2010

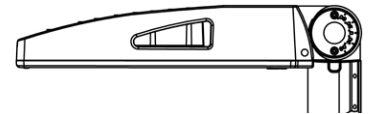
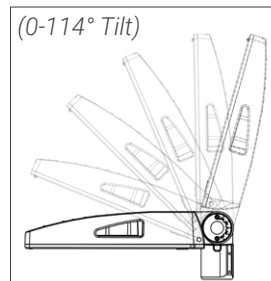

PRODUCT SPECIFICATIONS

BIRD SPIKES (BS)

Bird Spikes offers effective and humane deterrent for larger bird species and provides cost-effective long-term solution to nuisance bird infestations and protect your property.

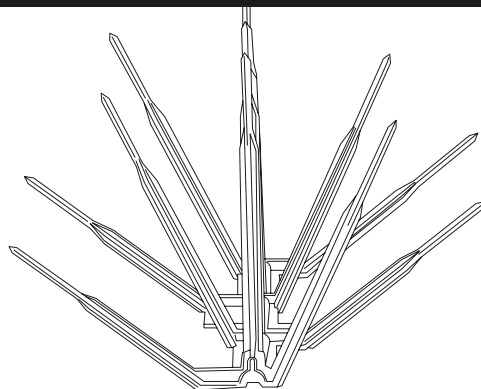

MARINE GRADE FINISH (MGF)

The **(MGF)** is a multi step process. Chemically washed in a 5 stage cleaning system. Pre-baked. Powder coated 3-5 mils of Zinc Rich Super Durable Polyester Primer. Oven Baked. Finished Powder Coating of Super Durable Polyester Powder Coat 3-5 mil thickness.



Powder Coat Finish
3-5 mil Powder Coat

Primer Layer
3-5 mil Zinc Rich Super Durable Polyester Primer

Prepared Casting
Chemically washed in multi Step 5 stage cleaning process

OPTIC PLATE PAINTED TO MATCH (OPP)

Optic plate is clear anodized as standard. The optic plate can be powder coated to match the finish of the fixture.

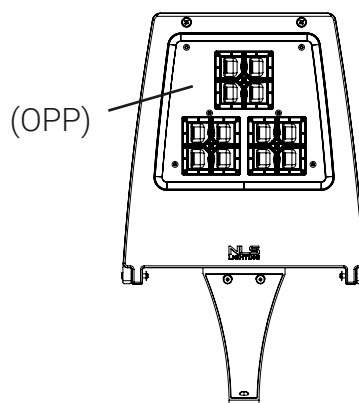

NEMA 7-PIN RECEPTACLE (PE7)

An ANSI C136.41-2013 receptacle provides electrical and mechanical interconnection between photo control cell and luminaire. Dimming receptacle available two or four dimming contacts supports 0-10 VDC dimming methods or Digital Addressable Lighting Interface (DALI), providing reliable power interconnect.

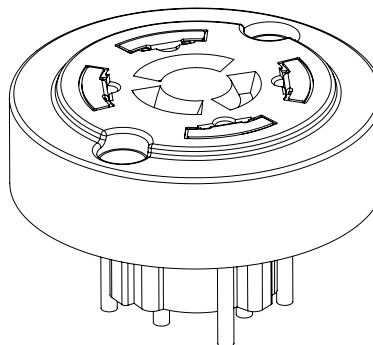

PRODUCT SPECIFICATIONS

PHOTOCELL + RECEPTACLE (PCR)

7-Pin Receptacle and Electronic Twist Lock Photocell for dusk to dawn operation.

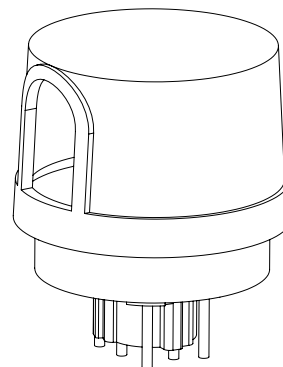

RECEPTACLE + SHORTING CAP (PER)

7-Pin Receptacle and Shorting Cap.

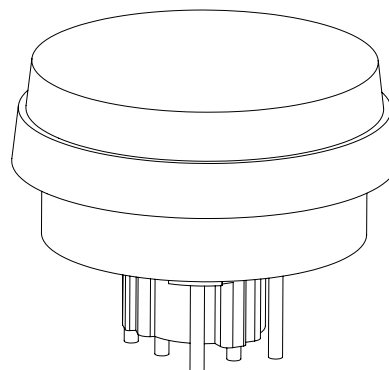

FSP-211 WITH MOTION SENSOR (FSP-XX)

- FSP-211 (FSP-X)—Passive infrared (PIR) sensor providing multi-level control based on motion/daylight contribution
- All control parameters adjustable via wireless configuration remote storing and transmitting sensor profiles
- FSP-20 mounting heights 9-20 feet
- FSP-40 mounting heights 21-40 feet
- Includes 5 dimming event cycles, 0-10V dimming with motion sensing, re-programmable in the field

FSP-211

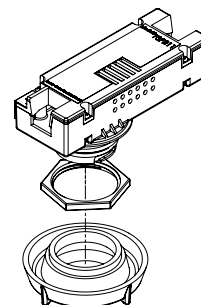

QUICK MOUNT BRACKET (QMB)

Optional Cast Aluminum Bracket designed for quick mounting on Direct Square or Round Poles. Cleat mounts directly to pole for easily hung fixtures. Has a 2"x4" Drill Pattern.



PRODUCT SPECIFICATIONS

RETROFIT MOUNT BRACKET (RQMB)

Optional Cast Aluminum Bracket designed for quick mounting on Direct Square or Round Poles. Cleat mounts directly to pole for easily hung fixtures. Drill Pattern is adjustable from 2"x4" to 2"x6".



ROUND POLE ADAPTER OPTIONS (RPA4) (RPA5)

When using round poles, specify Round Pole Adapter (RPA). Specify RPA4 when installing on 3"-4" round poles, and RPA5 when installing on 5"-6" round poles.

RPA4 / RPA5

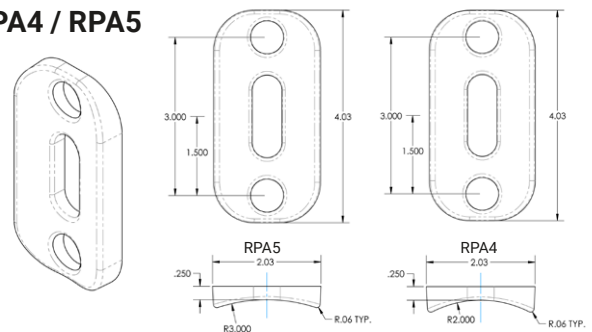

ROTATED OPTICS (ROL) (ROR)

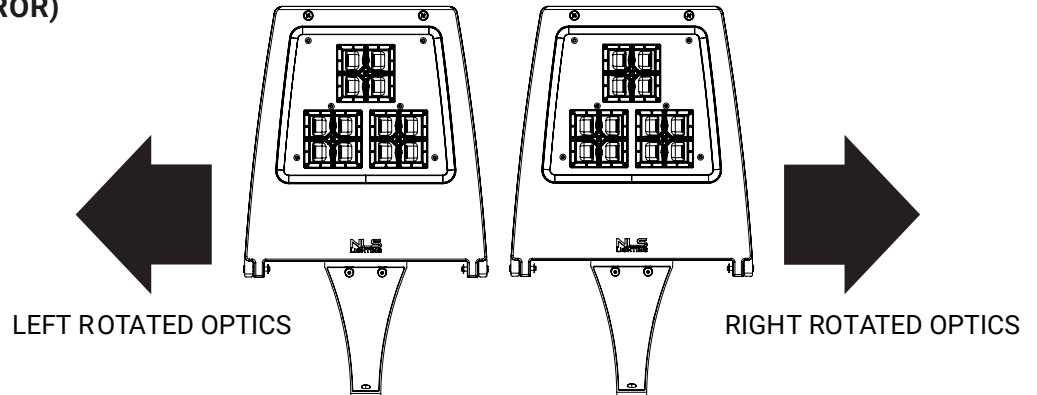

SHIELDING OPTIONS (AHS) (HSS)

SHIELDS (HSS, AHS)—House Side Shield (HSS) is designed for full property line cut-off.

HOUSE SIDE SHIELD

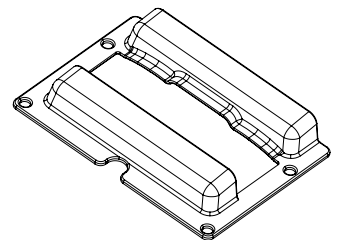

PRODUCT SPECIFICATIONS

LED KELVIN RANGE

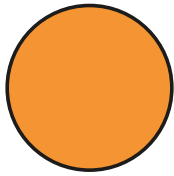

AMBER
585-600 nm

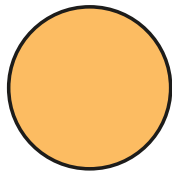

2700K 70 CRI

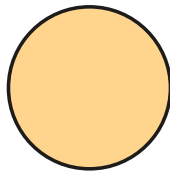

3000K 70 CRI

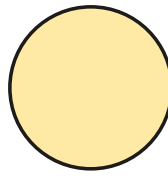

3500K 80 CRI

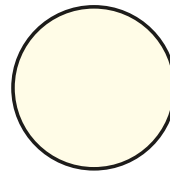

4000K 70 CRI

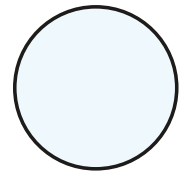

5000K 70 CRI

Color	Dominant or Peak Wavelength Range (nm)	
	Minimum	Maximum
Amber	585	600

BLACK HARDWARE

Optional black, zinc coated steel hardware.



BLACK OPTIC FRAME

Optional Black Optic Frame.
Standard is white.



PRODUCT SPECIFICATIONS

CONTROLS

- DIMMING CONTROL (FSP)—Passive infrared (PIR) sensor providing multi-level control based on motion/daylight contribution
- All control parameters adjustable via wireless configuration remote storing and transmitting sensor profiles
- FSP-8 mounting heights 8 feet and below
- FSP-20 mounting heights 9-20 feet
- FSP-40 mounting heights 21-40 feet
- Includes 5 dimming event cycles, 0-10V dimming with motion sensing, re-programmable in the field

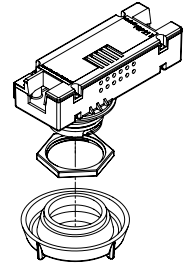

FSP-8

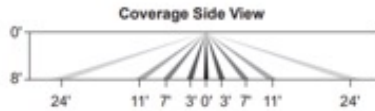
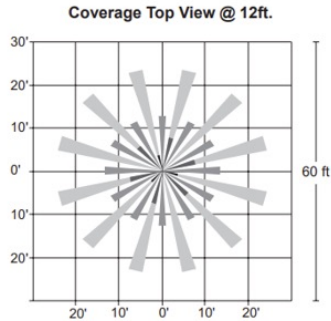

FSP-20

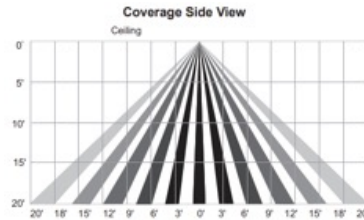
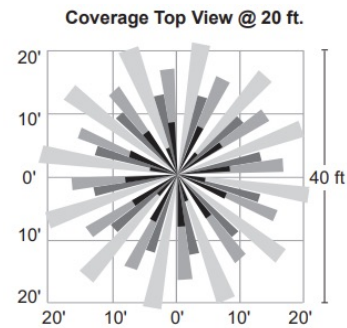

FSP-40

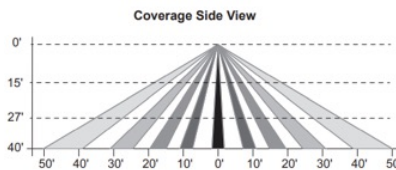
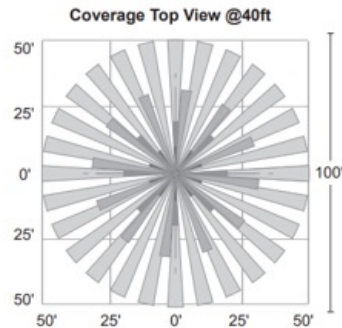



Job Name: PLATINUM HORIZON

Catalog #: CLI-NV-W-T4-1 □ L-7-40K7-UNV-WM-XX-XX-XX

TYPE:

WA



LED WATTAGE CHART

	16L	32L
400 milliamps	21w	-
530 milliamps	29w	-
700 milliamps	37w	71w
1000 milliamps	-	100w
1050 milliamps	56w	

KEY FEATURES

- Ideal for Exterior Walls, Entryways, Pathways, New Construction and Renovation, Warehouse and Receiving Docks, Court Yards, and School Playgrounds
- Sleek Minimalistic Design of the the NV-W (up to 11,000 Lumens, 12"W x 9"D x 5.5"H) Compliments the Design of the NV-W2 (up to 24,000 Lumens, 18"W x 9.38"D x 5"H)
- Amber, 2700K, 3000K, 3500K, 4000K, 5000K CCT Multichip High Power 70 & 80 CRI LEDs
- IP65 Rated Against Dust & Water Ingress, IK10 Rated for Tamper/ Vandalism/Impact Protection
- 20kA Surge Protection (120V - 480V) Cold Weather Integrated Battery Back-Up Safety Options
- Silicone Optics providing 96% Clarity and Heat Resistant up to 150°C
- 9 Standard Finishes, Custom Finish and Marine Grade Finish Available

- Controls Agnostic, Compatible with Most Control Systems and Sensors
- Environmentally Friendly Product Which Reduces Energy Consumption, L70 > 100,000 hours
- IDA qualified for 3000K CCT and Lower for Down-light Application, Reducing Light Pollution and Trespass
- Buy America(n) Option Available, Quick Mount for Easy Installation
- Cost Competitive and Short Shipping Lead Times in Days & Weeks

BUY AMERICAN

To ensure the latest BAA/TAA/BABA Standards are being met, please select BAA, TAA, or BABA in the options section. Please contact the factory before placing an order for any NLS products requesting BAA (Buy American Act), TAA (Trade American Act), or BABA (Build America, Buy America).



Project Name:

Type:

NV-W ORDERING GUIDE

Cat#	Light Dist.	# of LEDs	Miliamps	Kelvin	Volts
NV-W (NV-W)	Type 2 (T2)	16 (16L)	400 (40)	Amber 585-600nM (AMBER) ^{11,13,14}	120-277 (UNV)
	Type 3 (T3)	32 (32L)	530 (53)	2700K, 70 CRI (27K7) ⁷	347-480 (HV)
	Type 4 (T4)		700 (7)	2700K, 80 CRI (27K8) ^{1,7}	
			1000 (1A) ⁵	3000K, 70 CRI (30K7) ⁷	
			1050 (1) ⁶	3000K, 80 CRI (30K8) ^{1,7}	
				3500K, 80 CRI (35K8)	
				4000K, 70 CRI (40K7)	
				4000K, 80 CRI (40K8) ¹	
				5000K, 70 CRI (50K7)	
				5000K, 80 CRI (50K8) ¹	
Mounting	Color	Controls Options	Options	Lens Options	
Wall Mount (WM)	Bronze Textured (BRZ)	Nema 7-Pin Receptacle (PE7) ²	Marine Grade Finish (MGF)	Glass Lens (GL) ^{8,15}	
	White Textured (WHT)	Button Photocell (PC) ³	Vanity Plate 22"x16" (VP)	HAL Lens (HAL) ^{9,15}	
	Smooth White Gloss (SWT)	FSP-211 with Motion Sensor (UNV Voltage) *8' and Below (FSP-8) ³	Housing Extension (HE)		
	Silver Metallic (SVR)	*9'-20" Heights (FSP-20) ³	Surge Protector (20KA)		
	Black Textured (BLK)		Emergency Battery 4W (EM4) ^{2,3,4}		
	Smooth Black Gloss (SBK)		Emergency Battery 8W (EM8) ^{2,3,4}		
	Graphite Textured (GPH)		Emergency Cold Pk Battery 14W (EMCP) ^{2,3,4}		
	Grey Textured (GRY)		Black Hardware (BH)		
	Green Textured (GRN)		Black Optic Frame (BOF)		
	Hunter Green Textured (HGN)		Buy American Act (BAA) ¹²		
Custom (CS)		Trade Agreement Act (TAA) ¹²			
			Build America Buy American (BABA) ¹²		
			Custom Controls Integration (CCI) ¹⁰		

NOTES:

1. Consult Factory for Lead Time. Consult Factory for 90 CRI Requests
2. Requires Housing Extension
3. Universal Voltage 120-27
4. All Emergency Battery Options Certified CA Title 20
5. (1A) 32L only
6. (1) 16L only
7. 3000K or lower must be selected to meet International Dark Sky Association certification
8. Glass Lens: Low iron glass, fully tempered per ANSI C1047
9. HAL Lens: Yellow Polycarbonate Lens – less than 2% Blue Light Content
10. Please contact Factory for Custom Control Integration requests (nLight, NX, WaveLinx, Crestron, DMX/RDM, Synapse, Casambi, Dali II, Avi-On, or other control systems)
11. Turtle Safe
12. Consult factory for all BAA/TAA/BABA requests
13. Consult Factory for Lead Time
14. Not Available above 1000mA
15. Contact Factory



701 Kingshill Place, Carson, CA 90746
Call Us Today (310) 341-2037

nlsighting.com

PRODUCT SPECIFICATIONS

ELECTRICAL

- 120-277 Volts (UNV) or 347-480 Volts (HV)
- 0-10V dimming driver
- Driver power factor at maximum load is $\geq .95$, THD maximum load is 15%
- LED Drivers Ambient Temp. Min is -40°C and Ambient Temp. Max ranges from 50°C to 55°C and, in some cases, even higher. Consult the factory for revalidation by providing the fixture catalog string before quoting and specifying it.
- All internal wiring UL certified for 600 VAC and 105°C
- All drivers, controls, and sensors housed in enclosed IP66 compartment
- CRI 70, 80, 90
- Color temperatures: 2700K, 3000K, 3500K, 4000K, 5000K

CONSTRUCTION

- Die Cast Aluminum
- Internal cooling fins
- Corrosion resistant external hardware
- One-piece silicone gasket ensures IP65 seal for electronics compartment
- Two-piece silicone Micro Optic system ensures IP67 level seal around each PCB
- Silicone Micro Optics: Recessed, full cutoff, vandal resistant and non-yellowing
- Dark Sky Approved

OPTIONS

MARINE GRADE FINISH (MGF) - A multi-step process creating protective finishing coat against harsh environments. Chemically washed in a 5 stage cleaning system. Prebaked, Powder coated 3-5 mils of Zinc Rich Super Durable Polyester Primer. Oven Baked. Finished Powder Coating of Super Durable Polyester Powder Coat 3-5 mil thickness.

VANITY PLATE (VP) - Optional Vanity Plate was designed to cover the unsightly remains on a wall where a larger HID wallpack was removed. The aluminum Vanity Plate will be painted to match the finish of the NV-W2, custom finishes are available, please consult factory. The standard Vanity Plate is 22"W x 16"H.

20KA SURGE PROTECTOR (20KA) - protects the complete system against nominal surges of up to 20KA. Protection against power surges, storms and lightning strikes.

EMERGENCY BATTERY BACKUP

EMERGENCY COLD PACK BATTERY (EMPC) - Emergency cold pack (-20°C minimum) battery system available in 14W output.

BLACK HARDWARE (BH) - Black stainless steel hardware.

BLACK OPTIC FRAME (BOF) - Black optic frame. Standard is white.

GLASS LENS (GL) - Low Iron Glass, fully tempered.

HIGH PERFORMANCE AMBER LENS (HAL) -

CONTROL OPTIONS

- FSP-211 (FSP-X)—Passive infrared (PIR) sensor providing multi-level control based on motion/daylight contribution.
- All control parameters adjustable via wireless configuration remote storing and transmitting sensor profiles.
- FSP-8 Mounting heights 8 feet and below
- FSP-20 mounting heights 9-20 feet
- Includes 5 dimming event cycles, 0-10V dimming with motion sensing, re-programmable in the field. Programmable remote must be purchased separately.
- FSIR-100 commissioning remote is required to change sensor settings. Please contact factory for ordering.
- Controls Agnostic: Please contact factory for your preferred controls option.

NEMA 7-PIN RECEPTACLE (PE7)—An ANSI C136.41-2013 receptacle provides electrical and mechanical interconnection between photo control cell and luminaire. Dimming receptacle available two or four dimming contacts supports 0-10 VDC dimming methods or Digital Addressable Lighting Interface (DALI), providing reliable power interconnect.

BUTTON PHOTOCELL—Dusk to dawn optional Button Photocell.

FINISH

3-5 mils electrostatic powder coat. NLS Lighting's standard high-quality finishes prevent corrosion, and protects against extreme environmental conditions.

WARRANTY

Five-year limited warranty for drivers and LEDs.

OPTICS

Silicone optics high thermal stability and light output provide higher powered LEDs with minimized lumen depreciation. UV stability with scratch resistance increases exterior application durability. Silicone optics do not yellow, crack or brittle over time.

LISTINGS

- Certified to UL 1598
- UL 8750
- CSA C22.2 No. 250.0
- DesignLights Consortium® (DLC)
- DesignLights Consortium Premium® (DLCP)
- IP65 Rated Fixture / IP67 Rated Optics
- IK10 Rated
- IDA Dark Sky Approved

BUY AMERICAN OPTION

While all of the NLS Lighting products listed in this document qualify for the Buy America(n) Act of 1933, we reserve the right to change our listings without notice.

The information provided above is for general informational purposes only. We encourage you to consult legal professionals for advice particular to your projects concerning BAA, TAA, BABA or Buy America.

Additional NLS Products that meet BAA, TAA standards can be found at the following link:

<https://nslighting.com/buy-american/>



The information and specifications on this document are subject to change without any notification. All values are design, nominal, typical or prorated values when measured under internal and external laboratory conditions.



701 Kingshill Place, Carson, CA 90746
Call Us Today (310) 341-2037

nslighting.com

PRODUCT SPECIFICATIONS

LUMENS

PART NUMBER	T2	LM/W	T3	LM/W	T4	LM/W	WATTS
NV-W-16L-40-27K7	2561	122	2591	123	2561	122	21
NV-W-16L-40-27K8	2398	114	2426	116	2398	114	21
NV-W-16L-40-30K8	2571	122	2601	124	2571	122	21
NV-W-16L-40-30K7	2769	132	2801	133	2769	132	21
NV-W-16L-40-35K8	2571	122	2601	124	2571	122	21
NV-W-16L-40-40K8	2769	132	2801	133	2769	132	21
NV-W-16L-40-40K7	2992	142	3027	144	2992	142	21
NV-W-16L-40-50K8	2769	132	2801	133	2769	132	21
NV-W-16L-40-50K7	2992	142	3027	144	2992	142	21
NV-W-16L-53-30K7	3544	122	3579	123	3544	122	29
NV-W-16L-53-40K7	3756	130	3794	131	3756	130	29
NV-W-16L-53-50K7	3756	130	3794	131	3756	130	29
NV-W-16L-7-30K7	4388	119	4432	120	4388	119	37
NV-W-16L-7-40K7	4651	126	4698	127	4651	126	37
NV-W-16L-7-50K7	4651	126	4698	127	4651	126	37
NV-W-16L-1-30K7	5970	107	6029	108	5970	107	56
NV-W-16L-1-40K7	6328	113	6391	114	6328	113	56
NV-W-16L-1-50K7	6328	113	6391	114	6328	113	56
NV-W-32L-53-30K7	X	X	X	X	6,821	126	54
NV-W-32L-7-30K7	9010	127	9100	128	9010	127	71
NV-W-32L-7-40K7	9550	135	9646	136	9550	135	71
NV-W-32L-7-50K7	9550	135	9646	136	9550	135	71
NV-W-32L-1A-30K7	10871	109	10983	110	10871	109	100
NV-W-32L-1A-40K7	11426	114	11544	115	11426	114	100
NV-W-32L-1A-50K7	11426	114	11544	115	11426	114	100

3000K or lower, with fixed mounting options only, must be selected to meet International Dark-Sky Association certification.

EMERGENCY BATTERY BACK-UP LUMENS

PART NUMBER	T2	LM/W	T3	LM/W	T4	LM/W	WATTS
EM4-30K7	520	130	524	131	516	129	4
EM4-40K7	544	136	548	137	540	135	4
EM4-50K7	560	140	564	141	556	139	4
EM8-30K7	1040	130	1048	131	1032	129	8
EM8-40K7	1088	136	1096	137	1080	135	8
EM8-50K7	1120	140	1128	141	1112	139	8
EM14-30K7	2080	130	2096	131	2064	129	16
EM14-40K7	2176	136	2192	137	2160	135	16
EM14-50K7	2240	140	2256	141	2224	139	16
EMCP-30K7	1820	130	1834	131	1806	129	14
EMCP-40K7	1904	136	1918	137	1890	135	14
EMCP-50K7	1960	140	1974	141	1946	139	14



701 Kingshill Place, Carson, CA 90746
Call Us Today (310) 341-2037

nlsighting.com

PRODUCT SPECIFICATIONS

BUG RATINGS BUG RATINGS

PART NUMBER	T2	T3	T4	WATTS
NV-W-16L-35-30K7	B1-U0-G1	B1-U0-G1	B1-U0-G1	21
NV-W-16L-35-40K7	B1-U0-G1	B1-U0-G1	B1-U0-G1	21
NV-W-16L-35-50K7	B1-U0-G1	B1-U0-G1	B1-U0-G1	21
NV-W-16L-53-30K7	B1-U0-G1	B1-U0-G1	B1-U0-G1	29
NV-W-16L-53-40K7	B1-U0-G1	B1-U0-G1	B1-U0-G1	29
NV-W-16L-53-50K7	B1-U0-G1	B1-U0-G1	B1-U0-G1	29
NV-W-16L-7-30K7	B1-U0-G1	B1-U0-G1	B1-U0-G1	37
NV-W-16L-7-40K7	B1-U0-G1	B1-U0-G1	B1-U0-G1	37
NV-W-16L-7-50K7	B1-U0-G1	B1-U0-G1	B1-U0-G1	37
NV-W-16L-1-30K7	B1-U0-G1	B1-U0-G2	B1-U0-G2	56
NV-W-16L-1-40K7	B1-U0-G1	B1-U0-G2	B1-U0-G2	56
NV-W-16L-1-50K7	B1-U0-G1	B1-U0-G2	B1-U0-G2	56
NV-W-32L-7-30K7	B1-U0-G2	B2-U0-G2	B2-U0-G2	71
NV-W-32L-7-40K7	B1-U0-G2	B2-U0-G2	B2-U0-G2	71
NV-W-32L-7-50K7	B1-U0-G2	B2-U0-G2	B2-U0-G2	71
NV-W-32L-1A-30K7	B2-U0-G2	B2-U0-G2	B2-U0-G2	100
NV-W-32L-1A-40K7	B2-U0-G2	B2-U0-G2	B2-U0-G2	100
NV-W-32L-1A-50K7	B2-U0-G2	B2-U0-G2	B2-U0-G2	100

Lumen Maintenance Data

Ambient Temperature	Drive Current	L90 Hours*	L70 Hours**	30,000 Hours*	50,000 Hours*	60,000 Hours*	100,000 Hours**
25°C	Up to 700mA	58,000	173,000	95.7%	91.6%	89.6%	82.1%
	1050mA	48,000	143,000	94.3%	89.5%	87.2%	78.5%

*Reported extrapolations per IESNA TM-21 **Projected extrapolations per IESNA TM-21

LED KELVIN RANGE

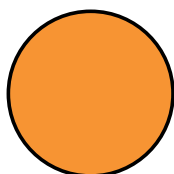

AMBER
585-600 nm

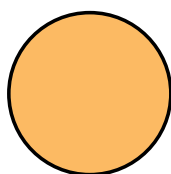

2700K 70 CRI

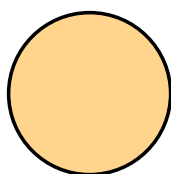

3000K 70 CRI

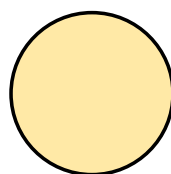

3500K 80 CRI

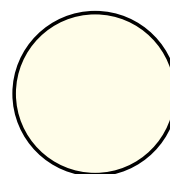

4000K 70 CRI

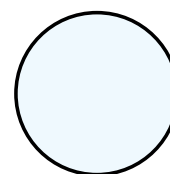

5000K 70 CRI

Color	Dominant or Peak Wavelength Range (nm)	
	Minimum	Maximum
Amber	585	600

PRODUCT SPECIFICATIONS

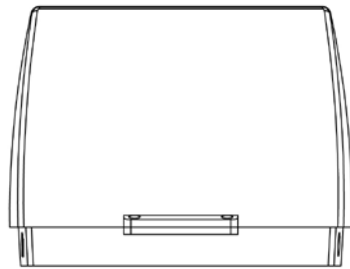

TOP VIEW

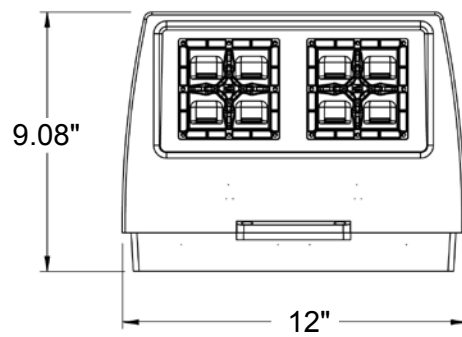

BOTTOM VIEW

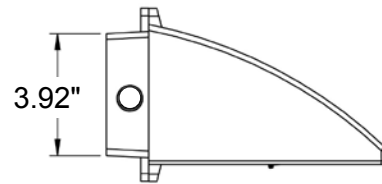
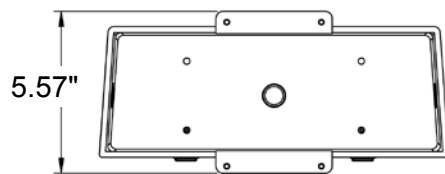

Weight: 9.1 lbs

EMERGENCY BATTERY AND 7-PIN EXTENSION BOX DIMENSIONS

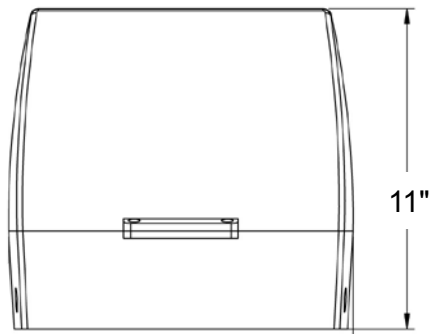

TOP VIEW

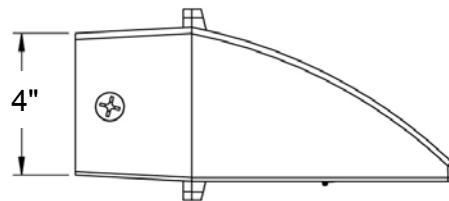

Weight: 13.3 lbs

PRODUCT SPECIFICATIONS

VANITY PLATE (VP)

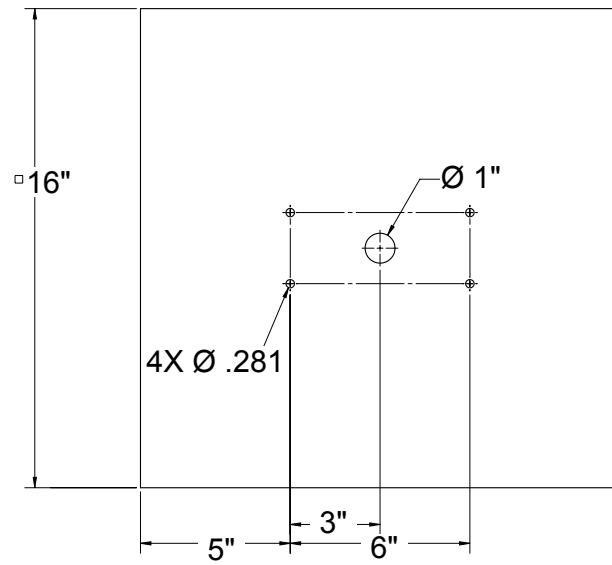

MOUNTING HOLE

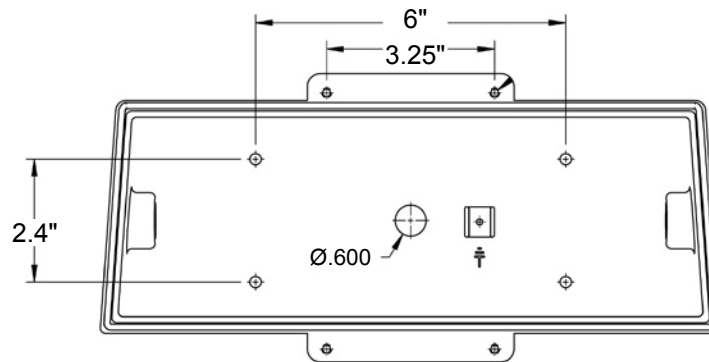

* 3 Conduit access points on either side or center back.

MOTION SENSOR PLACEMENT



FSP-8

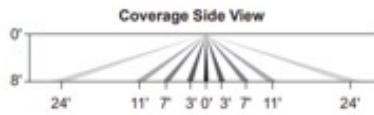
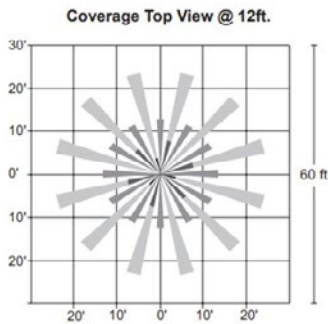

FSP-20

